

Mini Hi-Fi Component System

Operating Instructions

Owner's Record

The model and serial numbers are located on the rear of the unit. Record the serial number in the space provided below. Refer to them whenever you call upon your Sony dealer regarding this product.

Model No. _____ Serial No. _____



***FST-ZX100D/ZX80D
LBT-ZX100D/ZX80D
MHC-GN1000D***

WARNING

To reduce the risk of fire or electric shock, do not expose this apparatus to rain or moisture.

To prevent fire, do not cover the ventilation of the apparatus with newspapers, table-cloths, curtains, etc. And don't place lighted candles on the apparatus.

To prevent fire or shock hazard, do not place objects filled with liquids, such as vases, on the apparatus.

To avoid electrical shock, do not open the cabinet. Refer servicing to qualified personnel only.

Do not install the appliance in a confined space, such as a bookcase or built-in cabinet.

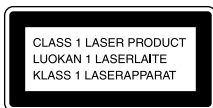

This appliance is classified as a CLASS 1 LASER product. This label is located on the rear exterior.



Don't throw away the battery with general house waste, dispose of it correctly as chemical waste.

The following caution label is located inside the apparatus.



NOTICE FOR THE CUSTOMERS IN THE U.S.A.

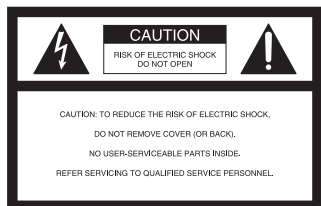

This symbol is intended to alert the user to the presence of uninsulated "dangerous voltage" within the product's enclosure that may be of sufficient magnitude to constitute a risk of electric shock to persons.



This symbol is intended to alert the user to the presence of important operating and maintenance (servicing) instructions in the literature accompanying the appliance.

WARNING

This equipment has been tested and found to comply with the limits for a Class B digital device, pursuant to Part 15 of the FCC Rules. These limits are designed to provide reasonable protection against harmful interference in a residential installation. This equipment generates, uses, and can radiate radio frequency energy and, if not installed and used in accordance with the instructions, may cause harmful interference to radio communications. However, there is no guarantee that interference will not occur in a particular installation. If this equipment does cause harmful interference to radio or television reception, which can be determined by turning the equipment off and on, the user is encouraged to try to correct the interference by one or more of the following measures:

- Reorient or relocate the receiving antenna.
- Increase the separation between the equipment and receiver.
- Connect the equipment into an outlet on a circuit different from that to which the receiver is connected.
- Consult the dealer or an experienced radio/TV technician for help.

CAUTION

You are cautioned that any changes or modification not expressly approved in this manual could void your authority to operate this equipment.

Note to CATV system installer:

This reminder is provided to call CATV system installer's attention to Article 820-40 of the NEC that provides guidelines for proper grounding and, in particular, specifies that the cable ground shall be connected to the grounding system of the building, as close to the point of cable entry as practical.

Table of Contents

About this manual	5
Playable discs	6

Getting Started

Hooking up the system	9
Positioning the speakers	12
Setting the clock	13
Performing QUICK SETUP	14
Using the THEATRE SYNC function	15
Changing the format of the video signal from COMPONENT VIDEO OUT jacks	16

Disc – Playback

Loading a disc	17
Playing a disc	17
— Normal Play	
Resuming playback from the point you stopped the disc	19
— Resume Play	
Creating your own program	20
— Program Play	
Playing in random order	21
— Shuffle Play	
Playing repeatedly	22
— Repeat Play	
Playing DVD VIDEOS using the menu	23
Selecting “ORIGINAL” or “PLAY LIST” on a DVD-R/ DVD-RW in VR mode	24
Playing VIDEO CDs with PBC functions (Version 2.0)	24
— PBC Playback	
About MP3 audio tracks and JPEG image files	25
Playing DATA CDs or DATA DVDs with MP3 audio tracks and JPEG image files	26
Playing MP3 audio tracks and JPEG image files as a slide show with sound	29

Using the on-screen display to search for a title/chapter/scene/track/ index/album/file	31
Searching by scene	33
— Picture Navigation	

Disc – Various Functions

Selecting the audio format	34
Changing the angles	35
Displaying the subtitles	35
Adjusting the delay between the picture and sound	36
— A/V SYNC	
Restricting playback of the disc	36
— CUSTOM PARENTAL CONTROL, PARENTAL CONTROL	
Using the DVD setup menu	40

Tuner

Presetting radio stations	47
Listening to the radio	49

Tape – Playback

Loading a tape	50
Playing a tape	50

Tape – Recording

Recording your favorite disc onto a tape	51
— CD Synchro Recording	
Recording onto a tape manually	51
— Manual Recording	

continued

Sound Adjustment

Adjusting the sound	52
Selecting the preset effect	52
Adjusting the graphic equalizer and storing the user equalizer setting	53
Selecting the sound field	53
Using the subwoofer	54
(FST-ZX100D/LBT-ZX100D/ MHC-GN1000D only)	
Creating a party environment.....	55
— X-TRANCE/X-TRANCE PRO	
Listening to the sound in another room.....	58
— Multi Room (FST-ZX100D/LBT-ZX100D/ FST-ZX80D/LBT-ZX80D only)	
Singing along: Karaoke.....	58
Mixing and recording sounds.....	63

Timer

Falling asleep to music.....	64
— Sleep Timer	
Waking up to music	64
— Play Timer	
Timer recording radio programs	65

Display

Turning off the display.....	66
— Power Saving Mode	
Changing the spectrum analyzer display.....	67
Adjusting the brightness of the front panel display	67
Changing the power illuminator	67
Viewing information about the disc in the front panel display	68
Viewing information about the disc in the on-screen display	69
Checking the date information of JPEG image files	70

Optional Components

Hooking up optional components.....	71
Listening to audio from a connected component	73
Recording audio signal from a connected component.....	73
Recording audio signal on a connected component.....	73

Troubleshooting

Problems and remedies.....	74
Self-diagnosis Function	79
Messages.....	80

Additional Information

Precautions	81
Specifications	82
Guide to the Control Menu display	86
DVD setup menu item list	89
Language code list	90
Glossary	91
List of button locations and reference pages.....	94

About this manual

- The instructions in this manual are for models FST-ZX100D, LBT-ZX100D, FST-ZX80D, LBT-ZX80D and MHC-GN1000D. In this manual, the LBT-ZX100D is used for illustration purposes unless stated otherwise.

The FST-ZX100D/LBT-ZX100D consists of:

- Tuner/DVD player/Stereo cassette deck/Amplifier (unit)
 - HCD-ZX100D
- Speaker System
 - Front speakers SS-ZX100D
 - Surround speakers SS-ZX100D
 - Center speaker SS-CT100D
 - Subwoofer SS-WGV100D

The FST-ZX80D/LBT-ZX80D consists of:







- Tuner/DVD player/Stereo cassette deck/Amplifier (unit)
 - HCD-ZX80D
- Speaker System
 - Front speakers SS-ZX100D
 - Surround speakers SS-ZX100D
 - Center speaker SS-CT100D

The MHC-GN1000D consists of:

- Tuner/DVD player/Stereo cassette deck/Amplifier (unit)
 - HCD-GN1000D
- Speaker System
 - Front speakers SS-GN1000D
 - Surround speakers SS-RSX1000D
 - Center speaker SS-CT1000D
 - Subwoofer SS-WGV1000D

- This instructions in this manual describe the controls on the remote. You can also use the controls on the unit if they have the same or similar names as those on the remote.
- The English on-screen display is used for illustration purposes only.
- The Control Menu items may be different depending on the disc.

- The following symbols are used in this manual.







Symbol	Meaning
	Functions available for DVD VIDEOS (including DVD-Rs/DVD-RWs/DVD+Rs/DVD+RWs in DVD VIDEO format and DVD-Rs/DVD-RWs in video mode).
	Functions available for DVD-Rs/DVD-RWs in VR (Video Recording) mode.
	Functions available for VIDEO CDs (including Super VCDs and CD-Rs/CD-RWs in VIDEO CD or Super VCD format).
	Functions available for AUDIO CDs (including CD-Rs/CD-RWs in AUDIO CD format).
	Functions available for DATA CDs (CD-ROMs/CD-Rs/CD-RWs) containing MP3 ¹⁾ audio tracks or JPEG image files.
	Functions available for DATA DVDs (DVD-ROMs/DVD-Rs/DVD-RWs/DVD+Rs/DVD+RWs) containing MP3 ¹⁾ audio tracks or JPEG image files.

¹⁾MP3 (MPEG 1 Audio Layer 3) is a standard format defined by ISO/MPEG which compresses audio data.

Playable discs

You can play back the following discs on this system. Other discs cannot be played back.

List of playable discs

Format of discs	Disc logo
DVD VIDEO	
DVD-RW/DVD-R	
DVD+RW/ DVD+R	
VIDEO CD	
AUDIO CD	
CD-R/CD-RW	

“DVD+RW”, “DVD-RW”, “DVD+R”, “DVD VIDEO”, and the “CD” logos are trademarks.

Notes on discs

The system can play back the following disc:

- CD-ROMs/CD-Rs/CD-RWs recorded in the following formats:
 - VIDEO CD format
 - AUDIO CD format
 - DATA CD format which contains MP3 audio tracks¹⁾ and JPEG image files of format conforming to ISO 9660²⁾ Level 1, Level 2 or Joliet in expansion format
- DVD-ROMs/DVD-Rs/DVD-RWs/DVD+Rs/DVD+RWs recorded in the following formats:
 - DVD VIDEO format
 - DATA DVD format which contains MP3 audio tracks¹⁾ and JPEG image files of format conforming to UDF (Universal Disk Format)
 - VR (Video Recording) format (DVD-Rs/DVD-RWs only)

The system cannot play back the following discs:

- CD-ROMs recorded in PHOTO CD format
- Data part of CD-Extras³⁾
- Data part of Mixed CDs⁴⁾
- Super Audio CDs
- DVD Audio discs
- DVD-RAMs
- A DVD VIDEO with a different region code.
- A disc that has a non-standard shape (e.g., heart, square, star).
- A disc that has the adhesive cellophane tape or a sticker still left on it.

¹⁾ MP3 audio tracks must be in MPEG 1 Audio Layer 3 format.

²⁾ ISO 9660 Format

A logical format of files and folders on CD-ROMs, defined by ISO (International Organization for Standardization).

³⁾ CD-Extra: This format records audio (AUDIO CD data) on the tracks in session 1 and data on the tracks in session 2.

⁴⁾ Mixed CD: This format records data on the first track and audio (AUDIO CD data) on the second and subsequent tracks of a session.

Region code of DVD VIDEOS you can play back on this system

Your system has a region code printed on the back of the unit and will only play back DVD VIDEOS labeled with identical region code. DVD VIDEOS labeled  will also be played back on this system.

If you try to play back any other region code DVD VIDEO, the message “Playback prohibited by area limitations.” will appear on the TV screen. Depending on the DVD VIDEO, no region code indication may be labeled even though playing the DVD VIDEO is prohibited by area restrictions.

Example:

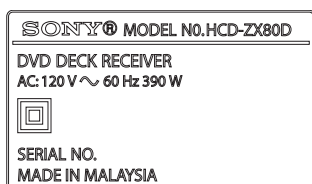

Region code



Note on DualDiscs

A DualDisc is a two sided disc product which mates DVD recorded material on one side with digital audio material on the other side. However, since the audio material side does not conform to Compact Disc (CD) standard, playback on this product is not guaranteed.

Notes on CD-R/CD-RW/DVD-R/ DVD-RW/DVD+R/DVD+RW

- In some cases, CD-Rs/CD-RWs/DVD-Rs/ DVD-RWs/DVD+Rs/DVD+RWs cannot be played back on this system due to the recording quality or physical condition of the disc, or the characteristics of the recording device and authoring software. The disc will not be played back if it has not been correctly finalized. For more information, see the operation instructions for the recording device.
- Note that some playback functions may not work with some DVD+RWs/DVD+Rs, even if they have been correctly finalized. In this case, view the disc by normal playback.
- A disc created in Packet Write format cannot be played back.

Note on playback operations of DVD VIDEOS and VIDEO CDs

Some playback operations of DVD VIDEOS and VIDEO CDs may be intentionally set by software producers. Since this system play back DVD VIDEOS and VIDEO CDs according to the disc contents the software producers designed, some playback features may not be available. Also, refer to the instructions supplied with the DVD VIDEOS or VIDEO CDs.

Note on PBC (Playback Control) (VIDEO CDs)

This system conforms to Ver. 1.1 and Ver. 2.0 of VIDEO CD standards. You can enjoy two kinds of playback depending on the disc type.

Disc type	You can
VIDEO CDs without PBC functions (Ver. 1.1 discs)	Enjoy video playback (moving pictures) as well as music.

continued

Disc type	You can
VIDEO CDs with PBC functions (Ver. 2.0 discs)	Play back interactive software using menu screens displayed on the TV screen (PBC Playback), in addition to the video playback functions of Ver. 1.1 discs. Moreover, you can play back high-resolution still pictures, if they are included on the disc.

Music discs encoded with copyright protection technologies

This product is designed to play back discs that conform to the Compact Disc (CD) standard. Recently, various music discs encoded with copyright protection technologies are marketed by some record companies. Please be aware that among those discs, there are some that do not conform to the CD standard and may not be playable by this product.

Notes on Multi Session disc

- This system can play back Multi Session discs when an MP3 audio track is contained in the first session. Any subsequent MP3 audio tracks recorded in later sessions can also be played back.
- This system can play back Multi Session discs when a JPEG image file is contained in the first session. Any subsequent JPEG image files recorded in later sessions can also be played back.
- If the first session is recorded in AUDIO CD or VIDEO CD format, only the first session will be played back.

- The system will recognize a Multi Session disc as an AUDIO CD if there is a session recorded in AUDIO CD format on the disc. However, the system will only play back the disc if the first session is recorded in AUDIO CD format.

Copyrights

This product incorporates copyright protection technology that is protected by U.S. patents and other intellectual property rights. Use of this copyright protection technology must be authorized by Macrovision, and is intended for home and other limited viewing uses only unless otherwise authorized by Macrovision. Reverse engineering or disassembly is prohibited.

This system incorporates Dolby* Digital, Dolby Pro Logic (II) adaptive matrix surround decoder, and the DTS** Digital Surround System.

* Manufactured under license from Dolby Laboratories.

“Dolby”, “Pro Logic”, and the double-D symbol are trademarks of Dolby Laboratories.

**Manufactured under license from Digital Theater Systems, Inc.

“DTS” and “DTS Digital Surround” are registered trademarks of Digital Theater Systems, Inc.

Hooking up the system

Do the following procedures **1** to **7** to hook up your system using the supplied cords and accessories.

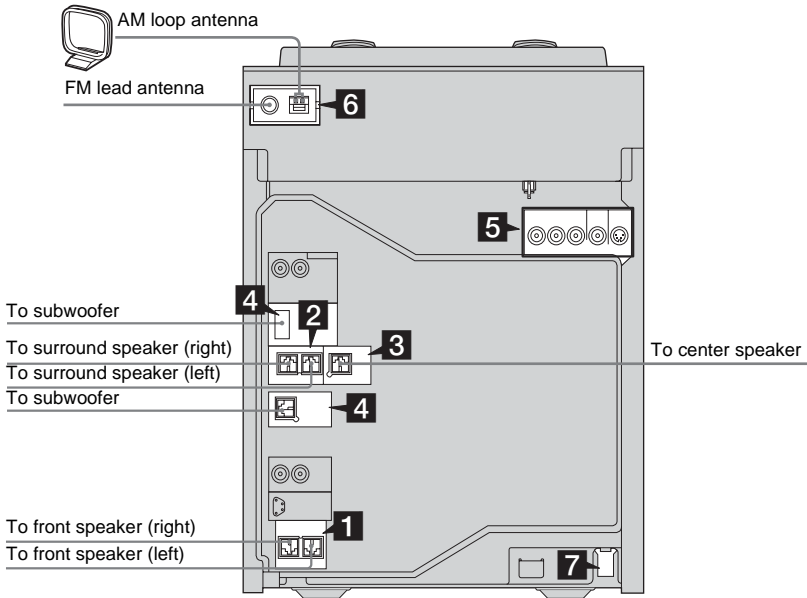

1 Connect the front speakers.

Connect the speaker cords of the front speakers to the FRONT SPEAKER terminals as shown below.

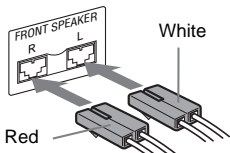

2 Connect the surround speakers.

Connect the speaker cords of the surround speakers to the SURR SPEAKER terminals as shown below.

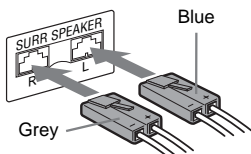

Tip

FST-ZX100D/LBT-ZX100D/FST-ZX80D/LBT-ZX80D only

Connect the speaker cords of the front and surround speakers to the terminals on the speakers.

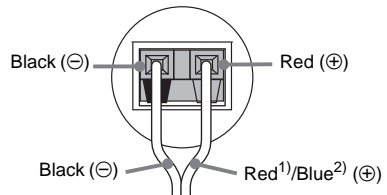

1) Front speakers only.

2) Surround speakers only.

3 Connect the center speaker.

Connect the speaker cord of the center speaker to the CENTER SPEAKER terminal as shown below.

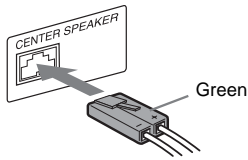

4 Connect the subwoofer. (FST-ZX100D/LBT-ZX100D/MHC-GN1000D only)

Connect the subwoofer cord to the SUBWOOFER OUT terminal and the system cord to the SYSTEM CONTROL jack as shown below.

SUBWOOFER OUT terminal

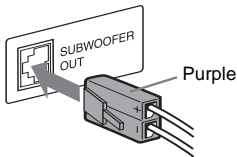

SYSTEM CONTROL jack

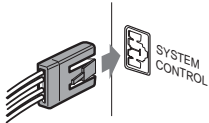

5 Connect the video input jack of your TV to the VIDEO OUT jack with the supplied video cord.

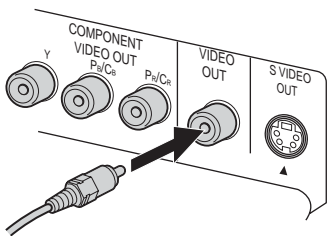

When using a TV

Turn on the TV and select the video input so that you can view the pictures from this system.

When connecting a video deck

Connect the video deck to the TV using a video cord (not supplied). However, do not connect this unit to the TV through the video deck. Otherwise, you may experience video leakage when watching video images from this system. Connect this unit directly to the TV as shown below.

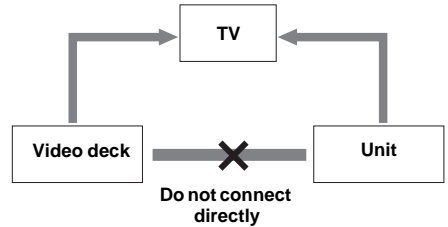

Tip

For higher quality video images:

- Use the optional component video cords to connect the COMPONENT VIDEO input jacks on your TV to the COMPONENT VIDEO OUT jacks of this unit. If your TV is compatible with progressive format file signals, use this connection and press PROGRESSIVE on the unit repeatedly until “P AUTO” or “P VIDEO” appears in the display (page 16).
- You can use an optional S Video cord to connect the S VIDEO input jack on your TV to the S VIDEO OUT jack of this unit.

6 Connect the FM and AM antennas.

Set up the AM loop antenna, then connect it.

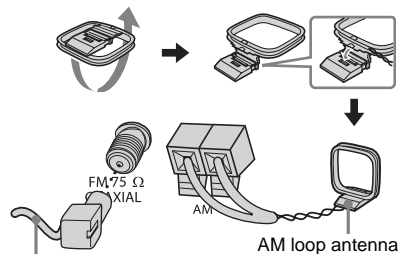

Extend the FM lead antenna horizontally

7 Connect the power cord to a wall outlet.

The demonstration appears in the display. When you press I/⏻, the system turns on and the demonstration automatically ends.

Notes

- Keep the speaker cords away from the antennas to prevent noise.
- Be sure to match the color of the speaker terminals on the unit and the connectors.
- Be sure to connect the speakers securely and correctly. When connecting speaker cords, insert the connector straight into the terminals.

To connect optional components

See “Hooking up optional components” on page 71.

Inserting two R6 (size AA) batteries into the remote

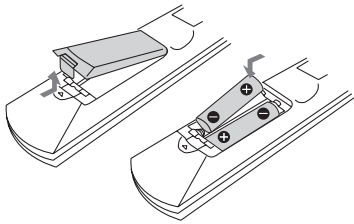

Operating a Sony TV

You can use the following buttons to operate a Sony TV. These buttons have been marked in orange. To use these buttons, hold down TV before pressing the button you want.

To	Hold down TV and press
Turn the TV on or off	TV I/⏻
Switch the TV's input source between the TV and other input sources	TV/VIDEO
Select the TV channels	TV CH +/- or numeric buttons*
Adjust the volume of the TV speaker(s)	TV VOL +/-

* For double digit number, hold down TV and press -/-. then press the number. (For example, hold down TV, press -/-. then 2 and 5 for entering 25.)

Note

If you do not use the remote for a long period of time, remove the batteries to avoid possible damage from battery leakage and corrosion.

Tip

With normal use, the batteries should last for about six months. When the remote no longer operates the system, replace both batteries with new ones.

Attaching the speaker pads

Attach the supplied speaker pads to the bottom of the speakers to stabilize the speakers and to prevent them from slipping.

Example

Front/surround speaker of FST-ZX100D

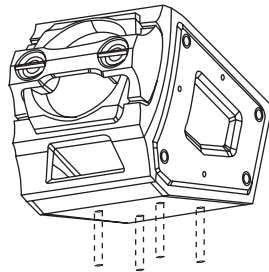

Front speaker of MHC-GN1000D

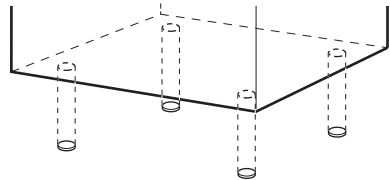

Subwoofer of FST-ZX100D

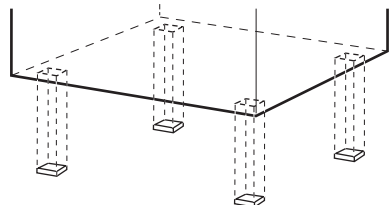

When carrying the unit

Do the following procedure to protect the disc mechanism.

Use the buttons on the unit for the operation.

- 1 Press I/⏻ to turn on the system.
- 2 Press DVD.
- 3 Press ▲ OPEN/CLOSE to open the disc tray and remove the disc. If there are more than one disc in the disc tray, press EX-CHANGE/DISC SKIP to remove the discs.
- 4 Press ▲ OPEN/CLOSE again to close the disc tray. Wait until "DVD No Disc" appears in the display.
- 5 Hold down DVD and then press I/⏻ until "STANDBY" appears in the display. Then, "MECHA LOCK" appears in the display.
- 6 Unplug the AC power cord.

When carrying the front and surround speakers

(FST-ZX100D/LBT-ZX100D/FST-ZX80D/LBT-ZX80D only)

Do not carry the front and surround speakers by their sub panel. Otherwise, the speakers may be damaged.

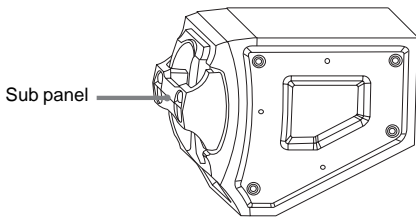

Positioning the speakers

FST-ZX100D/LBT-ZX100D/FST-ZX80D/LBT-ZX80D only

There are 3 different ways to place the speakers. To enjoy DVD VIDEOS or to create a party environment, we recommend that you place your speakers as shown in Example 1.

Example 1

Place the speakers at an equal distance from your listening position as shown below.

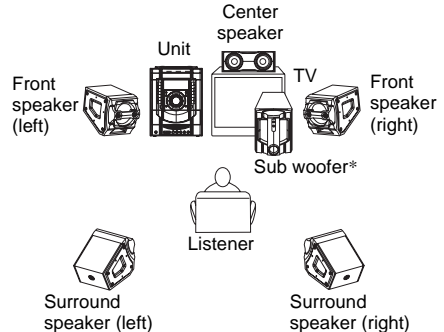

* Not supplied for FST-ZX80D/LBT-ZX80D

Example 2

Place the surround speakers on top of the front speakers as shown below.

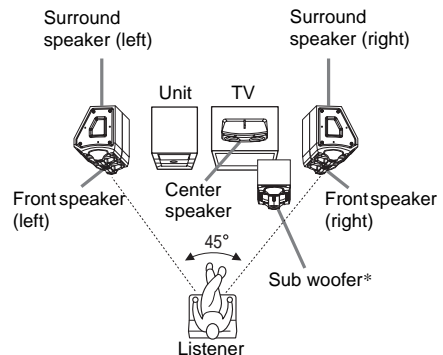

* Not supplied for FST-ZX80D/LBT-ZX80D

Example 3

Place the front speakers in one room and the surround speakers in another room. For details, see “Listening to the sound in another room” on page 58.

MHC-GN1000D only

Place the front speakers at an angle of 45 degrees from your listening position.

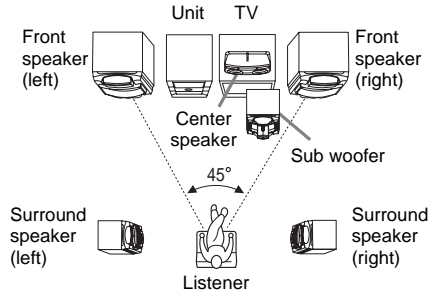
**Notes**

- Do not place the surround speakers on top of a TV. This may cause distortion of the colors in the TV screen.
- If you place the center speaker on the unit, be sure to place it at the front side of the unit.
- Place the subwoofer on solid floor where resonance is unlikely to occur so that a better bass reproduction could be obtained.
- Always place the subwoofer vertically, keeping it a few centimeters/inches away from the wall.
- If the subwoofer is placed in the center of a room, the bass could be extremely weakened. This is due to the influence of the standing wave of the room. If this happens, move the subwoofer away from the center of the room or eliminate the cause of the standing wave, by placing a bookshelf against the wall, etc.

Speaker settings

To enjoy DVD VIDEOS and other discs with multi-channel sound and Dolby surround effects, you need to adjust the speaker settings. For details, see “Setting the speakers” on page 44.

Setting the clock

- 1 Press I/⏻ to turn on the system.**
- 2 Press TIMER MENU.**
The hour indication flashes in the display.
- 3 Press ↑ or ↓ repeatedly to set the hour.**
- 4 Press ENTER.**
The minute indication flashes in the display.
- 5 Press ↑ or ↓ repeatedly to set the minute.**
- 6 Press ENTER.**
The clock starts functioning.

To adjust the clock

- 1 Press TIMER MENU.**
“PLAY SET?” flashes in the display.
- 2 Press ↑ or ↓ repeatedly to select “CLOCK SET?”, then press ENTER.**
The hour indication flashes in the display.
- 3 Do the same procedures as step 3 to 6 above.**

Notes

- The clock settings are canceled when you disconnect the power cord or if a power failure occurs.
- You cannot set the clock in Power Saving Mode (page 66).

Performing QUICK SETUP

Before using the system, you can make the minimum basic adjustments (LANGUAGE SETUP, SCREEN SETUP, SPEAKER SETUP) in QUICK SETUP. After performing QUICK SETUP, the system is ready for playback. To perform further speakers settings, see “Setting the speakers” on page 44.

1 Turn on your TV and select the video input.

2 Press **I/⏻** to turn on the system.

Note

Make sure that the headphone or microphone is not connected. Otherwise, you cannot perform SPEAKER SETUP.

3 Press **FUNCTION +/-** repeatedly to select “DVD” (or press **DVD** on the unit).

The guide message appears at the bottom of the TV screen.

4 Press **ENTER**.

The “LANGUAGE SETUP” display appears on the TV screen.

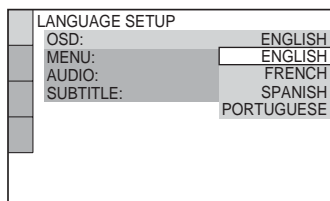

5 Press **↑** or **↓** repeatedly to select a language, then press **ENTER**.

Tips

- The selected language is for “OSD”, “MENU” and “SUBTITLE”.
- The selectable language is different depending on the area.

The setting is selected and the “SCREEN SETUP” display appears on the TV screen.

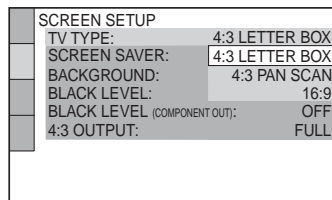

6 Press **↑** or **↓** repeatedly to select the setting that matches your TV type.

■ If you have a 4:3 standard TV

Select 4:3 LETTER BOX or 4:3 PAN SCAN (page 42)

■ If you have a wide-screen TV or a 4:3 standard TV with wide-screen mode

Select 16:9 (page 42)

7 Press **ENTER**.

The setting is selected and the “SPEAKER SETUP” display appears on the TV screen.

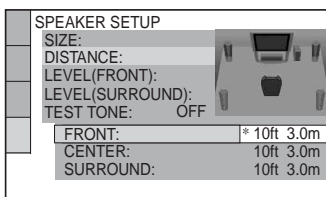







8 Press **↑** or **↓** repeatedly to select the front speaker distance from your listening position, then press **ENTER**.

You can set from 3 to 23 feet (0.9 to 6.9 meters). Repeat this step to adjust the center and surround speaker distance. For the center and surround speaker distance, you can set from 0 to 23 feet (0.0 to 6.9 meters). The setting is selected and “QUICK SETUP is complete.” appears on the TV screen.

To quit QUICK SETUP

Press **⏻** DISPLAY.

To change the settings of QUICK SETUP

- 1 Press  DISPLAY when playback is stopped.
The Control Menu appears on the TV screen.
- 2 Press  or  repeatedly to select (SETUP), then press ENTER. 
- 3 Press  or  repeatedly to select "QUICK", then press ENTER.
The "LANGUAGE SETUP" display appears on the TV screen.
- 4 Do the same procedures as steps 5 to 8 of "Performing QUICK SETUP".

Notes

- The guide message appears at the bottom of the TV screen when you turn on the system for the first time or after performing "RESET" (see "To return the DVD setup to the default settings*", perform reset as follows:" on page 79).
- If you do not want to perform QUICK SETUP, press CLEAR in step 3. The guide message will disappear from the TV screen.
- When there is a disc in the unit or the disc tray is opened, the guide message does not appear on the TV screen. To perform QUICK SETUP, press  OPEN/CLOSE on the unit to remove the disc and press again to close the disc tray.
- If you want to change each setting individually, see "Using the DVD setup menu" on page 40.

Using the THEATRE SYNC function

THEATRE SYNC allows you to turn on your Sony TV and this system, changes the system's function to "DVD" and then switches the TV's input source you have set with just one button.

Preparing for the THEATRE SYNC function

Register the TV's input source connected to this system.

Hold down SLEEP and press numeric buttons, CLEAR or ALBUM +/- to select the TV's input source connected to this system.

For details, refer to the following table.

Hold down SLEEP and press	To select the following TV's input source
0	No input source (Default)
1	VIDEO 1
2	VIDEO 2
3	VIDEO 3
4	VIDEO 4
5	VIDEO 5
6	VIDEO 6
7	VIDEO 7
8	VIDEO 8
9	COMPONENT 1
CLEAR	COMPONENT 2
ALBUM -	COMPONENT 3
ALBUM +	COMPONENT 4

The selected TV's input source is memorized into the remote.

Operating the THEATRE SYNC function

Point the remote to the direction of the TV and this unit, then press THEATRE SYNC.

If this function does not work, change the transmission time. The transmission time varies depending on the TV.

To change the transmission time

Hold down  and press numeric buttons to change the transmission time.

For details, refer to the following table.

Hold down  and press	To select the following transmission time
1	0.5 (Default)
2	1
3	1.5
4	2
5	2.5
6	3
7	3.5
8	4

The transmission time from the remote is selected.

continued

Notes

- This function is only available for Sony TV series.
- If distance between the TV and this unit is too far, this function may not work. Install the unit near the TV.
- Keep the remote pointed in the direction of the TV until the TV is turned on and the input source is changed correctly.

Changing the format of the video signal from COMPONENT VIDEO OUT jacks

Progressive is the method for displaying the TV images which reduces flickering and sharpens the image. To use this method, you need to connect to a TV that can accept progressive signals.

You can output video signals from COMPONENT VIDEO OUT jacks in INTERLACE or PROGRESSIVE format.

- 1 Press FUNCTION +/- repeatedly to select "DVD" (or press DVD on the unit).**
- 2 Press PROGRESSIVE on the unit repeatedly.**

Each time you press the button, the display changes cyclically as follows:

P AUTO → P VIDEO → INTERLACE

■ P AUTO (PROGRESSIVE AUTO)

Select this when your TV accepts progressive signals and the TV is connected to the COMPONENT VIDEO OUT jacks. The system automatically detects the software type and selects the appropriate conversion method.

■ P VIDEO (PROGRESSIVE VIDEO)

Select this when your TV accepts progressive signals and the TV is connected to the COMPONENT VIDEO OUT jacks.

The system fixes the conversion method to PROGRESSIVE VIDEO for video-based software.

Select this if the image is not clear when you select "P AUTO".

■ INTERLACE

Select this when your TV does not accept progressive signals or your TV is connected to the VIDEO OUT or S VIDEO OUT jack.

About DVD VIDEO software types and the conversion method

The DVD VIDEO software can be divided into 2 types:

- Film-based software
Film-based software is derived from film and displays the images at 24 frames per second.
- Video-based software
Video-based software is derived from TV, such as dramas and sitcoms and displays images at 30 frames or 60 fields per second.

Some DVD VIDEO contains both types of software. In order for these images to appear in your TV naturally when the video output is in progressive format, the progressive signals need to be converted to match your DVD VIDEO software.

Notes

- When you connect your TV to the COMPONENT VIDEO OUT jacks and play back video-based software in progressive signal format, some sections of the image may appear unnatural due to the conversion process.
- The image from VIDEO OUT and S VIDEO OUT jacks are always output in INTERLACE format even if you select "P AUTO" or "P VIDEO".
- There would be no image on your TV or the image is not clear if your setting does not match your TV or connection.
- "PROGRESSIVE" lights up in the display when you select "P AUTO" or "P VIDEO".

Disc – Playback

Loading a disc

Use the buttons on the unit for the operation.

- 1 Press ▲ OPEN/CLOSE.**
The disc tray slides out.
- 2 Load a disc with the label side facing up on the disc tray.**

When you play back an 8 cm disc such as a CD single, place it on the inner circle of the tray

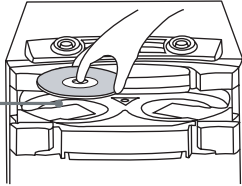

To load additional discs, press EX-CHANGE/DISC SKIP to rotate the disc tray.

- 3 Press ▲ OPEN/CLOSE to close the disc tray.**

Notes

- Do not forcibly push the disc tray to close it as this may cause a malfunction. Press ▲ OPEN/CLOSE to close the disc tray.
- When you eject a disc, handle the disc by its edge. Do not touch the surface of the disc.

Playing a disc

— Normal Play

DVD-V

DVD-VR

VIDEO CD

C D

DATA CD

DATA DVD

Before playing a DVD VIDEO, a VIDEO CD, or JPEG image files, turn on your TV and select the video input.

Depending on the DVD VIDEO or VIDEO CD, some operations may be different or restricted. Refer to the operating instructions supplied with the disc.

When playing a DVD VIDEO or DVD-R/ DVD-RW in VR mode:

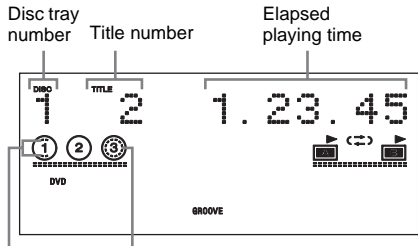

Disc playing indicator Disc presence indicator

When playing a VIDEO CD (playback without PBC function):

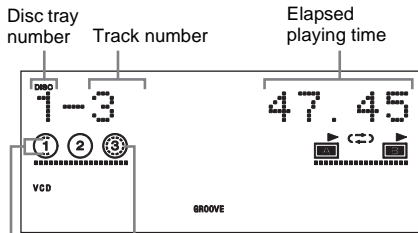

Disc playing indicator Disc presence indicator

When playing an AUDIO CD:

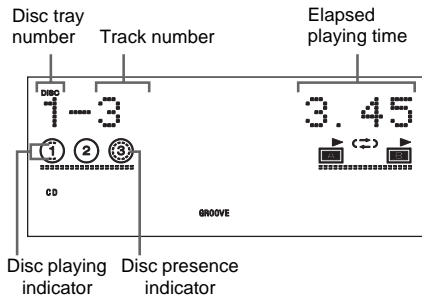

When playing an MP3 audio track:

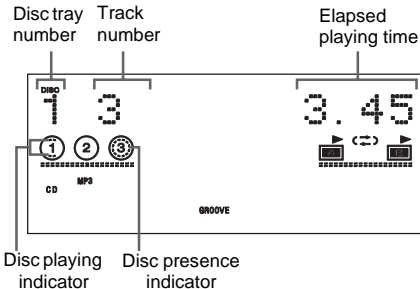

1 Press **FUNCTION +/-** repeatedly to select "DVD" (or press **DVD** on the unit).

2 Press **▷** (or **◀▶** on the unit).

3 Press **VOLUME +/-** (or turn **MASTER VOLUME** on the unit) to adjust the volume.

The volume level appears on the TV screen.

Note

Depending on the system status, the volume level may not appear on the TV screen.

Other operations

To	Do this
Stop playback	Press ■ .
Pause playback	Press ⏸ . Press ⏸ again or ▷ (or ◀▶ on the unit) to resume playback.
Select a track ¹⁾ , chapter or video file	Press ◀◀ or ▶▶ repeatedly during playback. Or, press the numeric buttons when the Control Menu is turned off, then press ENTER ²⁾ .

To	Do this
Select an album ³⁾	Press ALBUM +/- repeatedly during playback or when playback is paused.
Locate a point quickly in fast forward or fast reverse (Lock Search) ⁴⁾⁵⁾	Press ◀◀ or ▶▶ (or ◀◀◀◀ or ▶▶▶▶ on the unit) during playback. Each time you press ◀◀ or ▶▶ (or ◀◀◀◀ or ▶▶▶▶ on the unit), the playback speed changes cyclically as follows: Playback direction ⁶⁾ x2 ⁷⁾ → 1▶▶▶▶ → 2▶▶▶▶ → 3▶▶▶▶ ⁸⁾ Opposite direction ⁶⁾ x2 ⁹⁾ → 1◀◀◀◀ → 2◀◀◀◀ → 3◀◀◀◀ ⁸⁾ To return to normal playback, press ▷ (or ◀▶ on the unit).
Watch frame by frame (Slow-motion Play) ⁸⁾	Press SLOW ◀◀ or SLOW ▶▶ (or ◀◀◀◀ or ▶▶▶▶ on the unit) when playback is paused. Each time you press SLOW ◀◀ or SLOW ▶▶ (or ◀◀◀◀ or ▶▶▶▶ on the unit), the playback speed changes as follows: Playback direction ¹⁰⁾ 2▶▶ ↔ 1▶▶ Opposite direction ¹⁰⁾¹¹⁾ 2◀◀ ↔ 1◀◀ To return to normal playback, press ▷ (or ◀▶ on the unit).
Play one frame at a time (Freeze Frame) ⁸⁾	Press STEP ▶▶ to go to the next frame when playback is paused. Press ◀◀ STEP ¹¹⁾ to go to the preceding frame when playback is paused. To return to normal playback, press ▷ (or ◀▶ on the unit).
Replay the previous scene (Instant Replay) ¹¹⁾	Press REPLAY ◀◀ during playback.
Briefly fast forward the current scene (Instant Advance) ¹¹⁾	Press ADVANCE ▶▶ during playback.
Select a disc during playback or when playback is stopped	Press DISC SKIP on the remote (or one of the DISC 1 ~ 3 buttons on the unit).

To	Do this
Switch to DVD function from another source and start playback automatically	Press one of the DISC 1 ~ 3 buttons on the unit (Automatic Source Selection).
Exchange other discs after the disc's TOC reading is complete	Press EX-CHANGE/DISC SKIP on the unit.
Remove the disc	Press OPEN/CLOSE on the unit.

- 1) You cannot select an audio track during Lock Search operation of MP3 audio tracks.
- 2) DVD VIDEO, DVD-R/DVD-RW in VR mode, VIDEO CD and AUDIO CD only.
- 3) MP3 audio tracks and JPEG image files only.
- 4) Except for JPEG image files.
- 5) Depending on the disc, the actual speed may differ.
- 6) The “x2▶”/“x2◀” playback speed is about twice the normal speed. The “3▶▶”/“3◀◀” playback speed is faster than “2▶▶”/“2◀◀” and the “2▶▶”/“2◀◀” playback speed is faster than “1▶▶”/“1◀◀”.
- 7) DVD VIDEO and AUDIO CD only.
- 8) DVD VIDEO, DVD-R/DVD-RW in VR mode and VIDEO CD only.
- 9) DVD VIDEO only.
- 10) The “2▶▶”/“2◀◀” playback speed is slower than “1▶▶”/“1◀◀”.
- 11) DVD VIDEO and DVD-R/DVD-RW in VR mode only.

Notes

- You cannot search for a still picture on a DVD-R/DVD-RW in VR mode.
- You cannot perform Instant Replay and Instant Advance in Repeat Play mode.

Tips

- The Instant Replay function is useful when you want to review a scene or dialogue that you missed.
- The Instant Advance function is useful when you want to pass over a scene that you do not want to watch.
- You may not be able to use the Instant Replay or Instant Advance function with some scenes.
- If you press DVD on the unit while the system is turned off, the system turns on automatically and “DVD” is selected as the function except during Power Saving Mode.

Resuming playback from the point you stopped the disc

— Resume Play



This system memorizes the point where you stopped the disc so you can resume playback from that point. Resume Play is not canceled when you turn off the system except for MP3 audio tracks and JPEG image files.

1 While playing a disc, press to stop playback.

“Resume” appears in the display. If “Resume” does not appear, Resume Play is not available.

2 Press (or on the unit).

The system starts playback from the point you stopped the disc in step 1.

Notes

- You cannot perform Resume Play during Shuffle Play or Program Play.
- This function may not work properly with some discs.
- Depending on where you stopped the disc, the system may not resume playback from the exact same point.
- Resume Play is canceled when you
 - press when playback is stopped.
 - open the disc tray.
 - change the function.
 - change the settings in the Control Menu.
- If “MULTI-DISC RESUME” is set to “ON”, Resume Play is not canceled for DVD VIDEO and VIDEO CD when you open the disc tray or change the function.

Tip

To play back from the beginning of the disc, press twice, then press (or on the unit).

continued

Resuming playback of the disc that has been played back

— Multi-disc Resume

DVD-V **VIDEO CD**

This system can store the point where you stopped the playback of the disc for up to 40 discs and resumes playback when you insert the same disc again. If you store a playback resume point for the 41st disc, the playback resume point for the first disc will be deleted. To activate this function, set “MULTI-DISC RESUME” in “CUSTOM SETUP” to “ON”. For details, see “MULTI-DISC RESUME” on page 44.

Note

If “MULTI-DISC RESUME” is set to “ON”, the system may play back the next recorded disc such as a DVD-RW from the playback resume point for the current recorded disc. To start playback from the beginning of the disc, press **■** twice and then press **▷** (or **◀▶** on the unit).

Creating your own program

— Program Play

VIDEO CD **CD**

You can make a program of up to 99 steps in the order you want them to be played back. You can only program the tracks from the current disc.

1 Press **☰** DISPLAY.

The Control Menu appears on the TV screen.

2 Press **↑** or **↓** repeatedly to select **PROGRAM**, then press **ENTER**.



(PROGRAM), then press **ENTER**.

The options for “PROGRAM” appear on the TV screen.

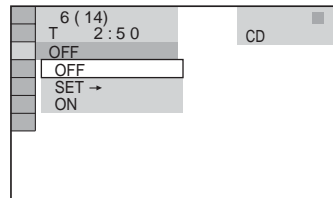

3 Press **↑** or **↓** repeatedly to select “SET→”, then press **ENTER**.

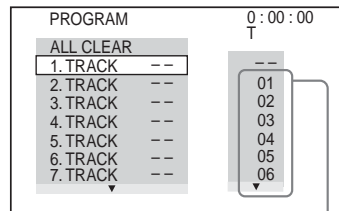

Tracks number

4 Press **→**.

The cursor moves to the track row “T” (in this case, “01”).

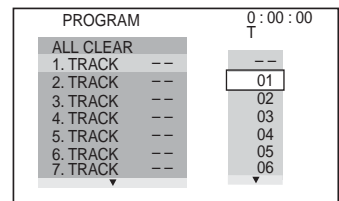

5 Select the track you want to program.

For example, select track “02”.

Press \uparrow or \downarrow repeatedly to select “02” under “T”, then press ENTER.

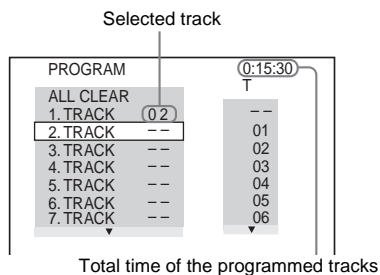

6 To program other tracks, repeat steps 4 to 5.

7 Press \triangleright (or $\blacktriangleleft\blacktriangleright$ on the unit).

Program Play starts.

When the Program Play ends, you can restart the same program by pressing \triangleright (or $\blacktriangleleft\blacktriangleright$ on the unit).

To cancel Program Play

Press CLEAR or select “OFF” in step 3. To play back the same program again, select “ON” in step 3 and press ENTER.

To change a programmed step

- 1 Follow steps 1 to 3 of “Creating your own program”.
- 2 Press \uparrow or \downarrow repeatedly to select the programmed step number you want to change. Then, press \rightarrow .
- 3 Follow step 5 of “Creating your own program” to program a new track.

To delete a programmed step

- 1 Follow steps 1 to 3 of “Creating your own program”.
- 2 Press \uparrow or \downarrow repeatedly to select the programmed step number you want to delete. Then, press CLEAR. The selected step is deleted. The following steps are shifted up.

To delete all of the programmed steps in the program list

- 1 Follow steps 1 to 3 of “Creating your own program”.
- 2 Press \uparrow to select “ALL CLEAR”.
- 3 Press ENTER.

To turn off the Control Menu

Press \square DISPLAY repeatedly until the Control Menu disappears from the TV screen.

Notes

- When Program Play is activated, the “REPEAT” setting is automatically changed to “ON” if the current setting is “ALL DISCS”, “ONE DISC” or “TRACK”.
- You cannot perform Program Play with VIDEO CDs during PBC playback.

Tip

The Program Play is canceled and the program list is cleared when

- you open the disc tray.
- you press DISC SKIP (or one of the DISC 1 ~ 3 buttons on the unit) to select another disc.
- you turn off the system.
- you change the function.
- you perform CD Synchro Recording.

Playing in random order

— Shuffle Play

VIDEO CD C D DATA CD DATA DVD

You can play back the tracks on the current disc in random order. Each time you perform Shuffle Play, the playing order may differ.

1 Press \square DISPLAY during playback.

The Control Menu appears on the TV screen.

2 Press **↑** or **↓** repeatedly to select

 (SHUFFLE), then press ENTER.

The options for “SHUFFLE” appear on the TV screen.

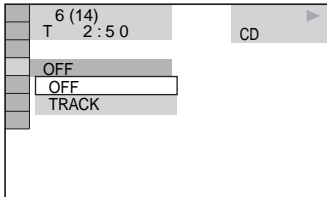

3 Press **↑** or **↓** repeatedly to select the setting you want.

■ When playing a VIDEO CD or AUDIO CD

- TRACK: all tracks on the current disc is played back randomly.

■ When Program Play is activated (see “Creating your own program” on page 20)

- ON: all tracks in the program list is played back randomly.

■ When playing a DATA CD or DATA DVD

- ON: all MP3 audio tracks in the selected album on the current disc is played back randomly.

When no album is selected, the first album is played back randomly.

4 Press ENTER

Shuffle Play starts.

“SHUF” lights up in the display.

To cancel Shuffle Play

Press CLEAR or select “OFF” in step 3.

To turn off the Control Menu

Press  DISPLAY repeatedly until the Control Menu disappears from the TV screen.

Notes

- Shuffle Play is only available for the tracks on the current disc.
- You cannot perform Shuffle Play with VIDEO CDs during PBC playback.
- Shuffle Play is canceled when
 - you open the disc tray.
 - you press DISC SKIP (or one of the DISC 1 ~ 3 buttons on the unit) to select other disc.
 - you turn off the system.
 - you change the function.
 - you perform Track/Index Search.
 - you perform CD Synchro Recording.
- The same song may be played back repeatedly for MP3 audio tracks.

Tip

You can also change the Shuffle Play setting when playback is stopped.

Playing repeatedly

— Repeat Play



You can play back all the titles, tracks, files or a single title, chapter, track or file on a disc repeatedly.

You can select Shuffle Play and Program Play at the same time.

1 Press DISPLAY during playback.

The Control Menu appears on the TV screen.

2 Press **↑** or **↓** repeatedly to select

 (REPEAT), then press ENTER.

The options for “REPEAT” appear on the TV screen.

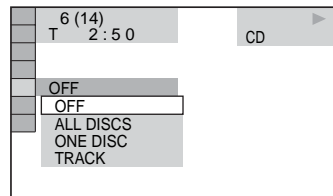

3 Press **↑** or **↓** repeatedly to select the setting you want.

The default settings are underlined.

■ When playing a DVD VIDEO or DVD-R/DVD-RW in VR mode

- OFF: does not play back repeatedly.
- ALL DISCS: repeats all the titles on all the discs.
- ONE DISC: repeats all the titles on the current disc.
- TITLE: repeats the current title.
- CHAPTER: repeats the current chapter.

■ When playing a VIDEO CD or AUDIO CD

- OFF: does not play back repeatedly.
- ALL DISCS: repeats all the tracks on all the discs.
- ONE DISC: repeats all the tracks on the current disc.
- TRACK: repeats the current track.

■ When playing a DATA CD or DATA DVD

- OFF: does not play back repeatedly.
- ALL DISCS: repeats all the tracks or files on all the discs.
- ONE DISC: repeats all the albums on the current disc.
- ALBUM: repeats the current album.
- TRACK¹⁾: repeats the current track.

■ When Program Play or Shuffle Play is activated

- OFF: does not play back repeatedly.
- ON: repeats the Program Play or Shuffle Play.

4 Press **ENTER**.

Repeat Play starts.

¹⁾ MP3 audio tracks only.

To cancel Repeat Play

Press **CLEAR** or select “OFF” in step 3.

To turn off the Control Menu

Press **DISPLAY** repeatedly until the Control Menu disappears from the TV screen.

Notes

- You can also change the Repeat Play setting by pressing **REPEAT** repeatedly.
- “REPEAT” lights up in the display when Repeat Play is set to “ALL DISCS”, “ONE DISC”, “ALBUM” or “ON”.
- “REPEAT1” lights up in the display when Repeat Play is set to “TITLE”, “CHAPTER” or “TRACK”.
- Depending on the DVD VIDEO, you cannot perform Repeat Play.
- You cannot perform Repeat Play with VIDEO CDs during PBC playback.
- When playing a DATA CD or DATA DVD which contains MP3 audio tracks and JPEG image files, the audio sound will not match the image if their playing time are different.
- You cannot select “TRACK” when “MODE (MP3, JPEG)” is set to “IMAGE (JPEG)”.
- Repeat Play is canceled when
 - you open the disc tray.
 - you press **DISC SKIP** (or one of the **DISC 1 ~ 3** buttons on the unit) to select other disc (unless Repeat Play is set to “ALL DISCS”).
 - you turn off the system
 - you change the function (unless Repeat Play is set to “ALL DISCS”).
 - you perform CD Synchro Recording.

Tip

You can also change the Repeat Play setting when playback is stopped.

Playing DVD VIDEOS using the menu

DVD-V

Some DVD VIDEOS have menus to help you enjoy the DVD VIDEOS. You can play back DVD VIDEOS using these menus on the TV screen.

Using TOP MENU

A DVD VIDEO contains a lot of sections of picture or music feature called “title”. When you play back a DVD VIDEO which contains several titles, you can select the title you want using **TOP MENU**.

Using MENU

Some DVD VIDEOS allow you to select the disc contents using a menu. When you play back these DVD VIDEOS, you can select items such as the language for the subtitles and the language for the sound using MENU.

1 Press TOP MENU or MENU.

The menu appears on the TV screen. The contents of the menu vary depending on the disc.

2 Press \uparrow and \downarrow or \leftarrow and \rightarrow or the numeric buttons to select the title or item you want to play back.

3 Press ENTER.

Selecting “ORIGINAL” or “PLAY LIST” on a DVD-R/DVD-RW in VR mode

DVD-VR

You can play back DVD-Rs/DVD-RWs in VR mode either according to the originally recorded sequence or to the playlist created on the disc. This function is only available for DVD-Rs/DVD-RWs in VR mode with a playlist created.

1 Press \square DISPLAY when playback is stopped.

The Control Menu appears on the TV screen.

2 Press \uparrow or \downarrow repeatedly to select \square (ORIGINAL/PLAY LIST), then press ENTER.

The options for “ORIGINAL/PLAY LIST” appear on the TV screen.

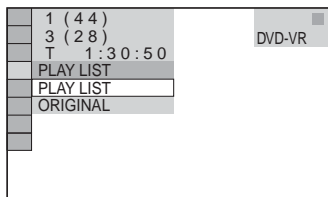

3 Press \uparrow or \downarrow repeatedly to select the setting you want.

- PLAY LIST: play back according to the playlist created on the disc.
- ORIGINAL: play back according to the originally recorded sequence.

4 Press ENTER.

Playing VIDEO CDs with PBC functions (Version 2.0)

— PBC Playback

VIDEO CD

You can use the PBC (Playback Control) menus on your TV screen to enjoy the disc’s interactive software. The menu format and structure may differ depending on each disc.

1 Press \triangleright (or \blacktriangleleft on the unit) to start playing a VIDEO CD with PBC functions (Version 2.0).

The PBC menu appears on the TV screen.

2 Press the numeric buttons to select the item number you want.

3 Press ENTER.

4 Continue playback according to the instructions on the menus to enjoy interactive playback.

Refer to the operating instructions supplied with the VIDEO CD, as the operating procedure may differ depending on the VIDEO CD.

To return to the previous menu

Press \curvearrowright RETURN.

Notes

- Depending on the VIDEO CD, the menu may not appear in step 1.
- Depending on the VIDEO CD, “Press ENTER” in step 3 may appear as “Press SELECT” in the operating instructions supplied with the disc. In this case, press \triangleright (or \blacktriangleleft on the unit).
- PBC Playback is canceled when Shuffle Play, Program Play or Repeat Play is activated.

To cancel playback with PBC functions

- 1 Press ◀◀ or ▶▶ repeatedly or press the numeric buttons to select a track when playback is stopped.
- 2 Press ▷ (or ◀▶ on the unit) or ENTER.

“Play without PBC.” appears on the TV screen and playback starts from the selected track. Still images, such as the menu screens, will not be shown.

To return to PBC playback, press ■ twice, then press ▷ (or ◀▶ on the unit).

About MP3 audio tracks and JPEG image files

DATA CD DATA DVD

What is MP3/JPEG?

MP3 is an audio compression technology that satisfies the ISO/MPEG regulations. JPEG is an image compression technology.

Discs that the system can play back

For details on DATA CDs (CD-ROMs/CD-Rs/CD-RWs) or DATA DVDs (DVD-ROMs/DVD-Rs/DVD-RWs/DVD+Rs/DVD+RWs) that the system can play back, see “Notes on discs” (page 6) and “Notes on Multi Session disc” (page 8).

MP3 audio tracks or JPEG image files that the system can play back

The system can play back MP3 audio tracks which have the extension “.MP3” and JPEG image files which have the extension “.JPG” or “.JPEG”.

Playback order of MP3 audio tracks or JPEG image files

The playback order of MP3 audio tracks or JPEG image files recorded on a DATA CD or DATA DVD is as follows:

■ Structure of disc contents

Tree 1 Tree 2 Tree 3 Tree 4 Tree 5

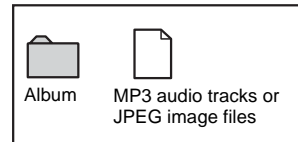
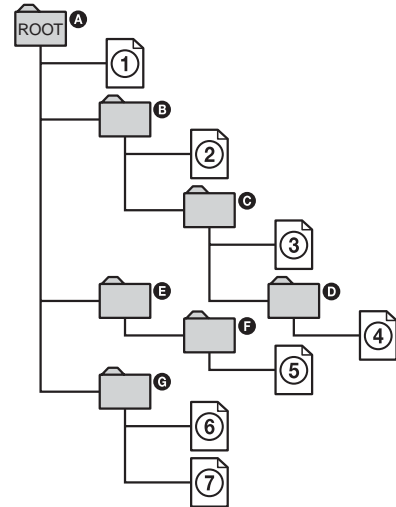

When you insert a DATA CD or DATA DVD and press ▷ (or ◀▶ on the unit), the tracks (or files) are played back sequentially, from ① through ⑦. Any sub-albums or sub-files in the selected album take priority over the next album in the same tree. (Example: C contains D so ④ is played back before ⑤.)

When you press MENU and the list of album names appears (page 27), the album names are arranged in the following order:

A → B → C → D → F → G. Albums that do not contain tracks (or files) (such as album E) do not appear in the list.

continued

Notes

- Depending on the software you use to create the DATA CD or DATA DVD, the playback order may differ from the illustration above.
 - The playback order above may not be applicable if there are more than 200 albums and 300 files in each album.
 - The system can recognize up to 200 albums including albums that do not contain MP3 audio tracks and JPEG image files. The system will not play back any albums beyond the 200th album.
 - The maximum number of MP3 audio tracks or JPEG image files on an album which this system can recognize is:
 - 600 when “MODE (MP3, JPEG)” is set to “AUDIO (MP3)” or “IMAGE (JPEG)”.
 - 300 when “MODE (MP3, JPEG)” is set to “AUTO”.
 - The system may take a longer time to start playback, when the tracks or files in another album has just been played back.
 - An album that does not contain an MP3 audio track or JPEG image file is skipped.
 - The system will play back any data with the extension “.MP3”, “.JPG” or “.JPEG” even if they are not in MP3 or JPEG format. Playing this data may generate a loud noise which could damage your speaker system.
 - The system does not support MP3PRO format.
 - The system can only play back MP3 audio tracks in MPEG 1 Audio Layer 3 format.
 - Depending on the encoding/writing software, recording device, or the recording media used to record an MP3 audio track, you may encounter problems such as cannot play back, sound interruptions and noise.
 - The following discs take a longer time to start playback:
 - a disc recorded with complicated tree structure.
 - a disc recorded in Multi Session.
 - a disc to which data can be added (non finalized disc).
 - Some CD-Rs/CD-RWs/DVD-Rs/DVD-RWs/DVD+Rs/DVD+RWs cannot be played back on the system depending on the file format.
- When playing a DATA CD (CD-ROMs/CD-Rs/CD-RWs) or DATA DVD (DVD-ROMs/DVD-Rs/DVD-RWs/DVD+Rs/DVD+RWs) containing both MP3 audio tracks and JPEG image files, select “MODE (MP3, JPEG)” from the Control Menu after the disc’s TOC reading is complete. If you want to play back
 - both MP3 audio tracks and JPEG image files, set “MODE (MP3, JPEG)” to “AUTO”.
 - MP3 audio tracks only, set “MODE (MP3, JPEG)” to “AUDIO (MP3)”.
 - JPEG image files only, set “MODE (MP3, JPEG)” to “IMAGE (JPEG)”.
 - The system can play back to a depth of 8 folders only.

Tips

- If you add numbers (01, 02, 03, etc.) to the front of the track or file names when you store the tracks or files in a disc, the tracks and files will be played back in that order.
- Since a disc with many trees takes a longer time to start playback, it is recommended that you create albums with no more than two trees.

Playing DATA CDs or DATA DVDs with MP3 audio tracks and JPEG image files

DATA CD DATA DVD

Playing an album of MP3 audio tracks or an MP3 audio track

1 Load a DATA CD or DATA DVD on the disc tray.

The list of albums appears on the TV screen.



2 Do the following steps to play back an album of MP3 audio tracks or an MP3 audio track.

■ Playing an album of MP3 audio tracks

Press **▲** or **▼** repeatedly to select the album you want, then press **▷** (or **◀▶** on the unit).

The system starts playback from the first track of the selected album.

■ Playing an MP3 audio track

1 Press **▲** or **▼** repeatedly to select the album you want, then press **ENTER**.

The list of MP3 audio tracks of the selected album appears on the TV screen.

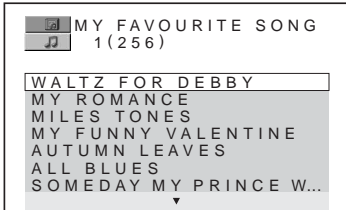

2 Press **▲** or **▼** repeatedly to select the MP3 audio track you want, then press **ENTER**.
The system starts playing the selected MP3 audio track.

To stop playback

Press **■**.

To display the next or previous page of track list or album list

Press **◀** or **▶** repeatedly when the track list or album list is displayed.

To play back the next or previous MP3 audio track

Press **◀◀** or **▶▶** repeatedly during playback.

To play back the next album of MP3 audio tracks

You can select the next album by pressing **▶▶** repeatedly until the last track of the current album, then press **▶▶** once. The first track of the next album is selected. However, you cannot select the previous album by pressing **◀◀** repeatedly. To select the previous album, select the album from the album list.

To return to the album list display when the track list is displayed

Press **↶** RETURN.

To turn on or off the display of album list or track list

Press **MENU** repeatedly.

Notes

- You can view the disc information while playing MP3 audio tracks (page 68).
- You can select Repeat Play while playing MP3 audio tracks (page 22).
- You can press **AUDIO** to select the audio signal you want while playing an MP3 audio track (page 34).

Playing an album of JPEG image files or a JPEG image file

1 Load a **DATA CD** or **DATA DVD** on the disc tray.

The list of albums appears on the TV screen.

2 Do the following steps to play back an album of JPEG image files or a JPEG image file.

■ Playing an album of JPEG image files

Press **▲** or **▼** repeatedly to select the album you want, then press **▷** (or **◀▶** on the unit).

The system starts a slide show from the first image file of the selected album.

■ Playing a JPEG image file

- 1 Press **▲** or **▼** repeatedly to select the album you want, then press PICTURE NAVI. Thumbnail picture for the first 16 JPEG image files in the selected album is displayed on the TV screen.

1	2	3	4
5	6	7	8
9	10	11	12
13	14	15	16

If there are more than 16 image files in the selected album, the scroll bar appears at the right. Press **▼** repeatedly until the bottom row of the thumbnail picture. Then, press **▼**.

The TV screen will show the thumbnail picture of the next 16 image files.

To return to the thumbnail picture of the previous 16 image files, press **▲** repeatedly until the top row of the thumbnail picture. Then, press **▲**.

- 2 Press **▲/▼/◀/▶** to select the image you want to view, then press **▷** (or **◀▶** on the unit). The slide show starts from the selected image file.

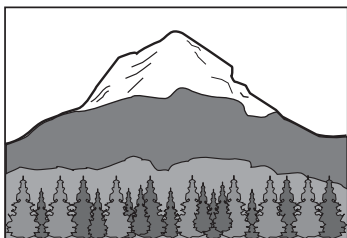

To display the next or previous page of album list

Press **◀** or **▶** repeatedly when the album list is displayed.

To display the next or previous JPEG image file

Press **◀** or **▶** repeatedly during the slide show.

To play back the next album of JPEG image files

You can select the next album by pressing **▶** repeatedly until the last file of the current album, then press **▶** once. The first file of the next album is selected. However, you cannot select the previous album by pressing **◀** repeatedly. To select the previous album, select the album from the album list.

To turn on or off the display of album list

Press MENU repeatedly.

To rotate a JPEG image file

When a JPEG image file is displayed on the TV screen, you can rotate the image by 90 degrees. Press **▲** or **▼** repeatedly while viewing an image. Each time you press **▲**, the image rotates counterclockwise by 90 degrees.

Example: When you press **▲** once

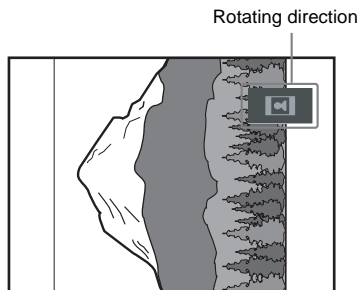

Press CLEAR to return to the original view.

To stop playback

Press **■**.

Notes

- When you press **◀** or **▶** to select the next or previous image, the image will return to its original view even if you have rotated the image previously.
- The slide show stops when you press **▲** or **▼**.
- You can view the file information while playing JPEG image files (page 70).
- You can select Repeat Play while playing JPEG image files (page 22).

Tip

You can also change the slide show speed (page 30) and effect (page 30) while playing JPEG image files.

Playing MP3 audio tracks and JPEG image files as a slide show with sound

DATA CD DATA DVD

You can play back a slide show with sound by first placing both JPEG image files and MP3 audio tracks in the same album on a DATA CD or DATA DVD.

1 Load a DATA CD or DATA DVD on the disc tray.

The list of albums appears on the TV screen.

2 Press DISPLAY.

The Control Menu appears on the TV screen.

3 Press or repeatedly to select (MODE (MP3, JPEG)), then press ENTER.

The options for “MODE (MP3, JPEG)” appear on the TV screen.

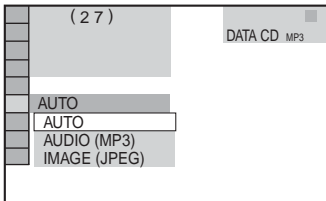

The default setting is underlined.

- AUTO: play back both JPEG image files and MP3 audio tracks in the same album as a slide show with sound.
- AUDIO (MP3): play back MP3 audio tracks continuously.
- IMAGE (JPEG): play back JPEG image files as a slide show.

4 Press or repeatedly to select “AUTO”, then press ENTER.

5 Press MENU.

The list of albums appears on the TV screen.

6 Press or repeatedly to select the album you want, then press (or on the unit).

The slide show with sound starts from the selected album.

To stop playback

Press .

To turn on or off the display of album list

Press MENU repeatedly.

To cancel slide show with sound

Select “AUDIO (MP3)” or “IMAGE (JPEG)” in step 4.

Notes

- In some cases, you cannot change the “MODE (MP3, JPEG)” setting when “MODE (MP3, JPEG)” has been set to
 - “IMAGE (JPEG)” and the selected disc only contains MP3 audio tracks.
 - “AUDIO (MP3)” and the selected disc only contains JPEG image files.
- You cannot play back JPEG image files and MP3 audio tracks at the same time if they are not contained in the same album.
- When the playback duration of the JPEG image files is longer than the MP3 audio tracks, the slide show continues without sound.
- When the playback duration of the MP3 audio tracks is longer than the JPEG image files, the MP3 audio tracks are played back without the slide show.
- If there are no MP3 audio tracks in the DATA CD or DATA DVD and “MODE (MP3, JPEG)” is set to “AUDIO (MP3)”, “No audio data” appears on the TV screen and the disc cannot be played back.
- If there are no JPEG image files in the DATA CD or DATA DVD and “MODE (MP3, JPEG)” is set to “IMAGE (JPEG)”, “No image data” appears on the TV screen and the disc cannot be played back.
- The PICTURE NAVI button does not work when “MODE (MP3, JPEG)” is set to “AUDIO (MP3)”.
- If you play back a large data size of MP3 audio tracks and JPEG image files at the same time, the sound may skip. It is recommended that you reduce the data size by creating the MP3 audio tracks with a bit rate of 128 kpbs or lower. If the skipping sound still occurs, reduce the data size of JPEG image files by creating the JPEG image files in smaller size or lower resolution.

continued

Tips

- You can also change the slide show speed (page 30) and effect (page 30) while playing JPEG image files.
- If you want to play back a slide show to the same audio track, set the track to Repeat Play (page 22).

Specifying the slide show speed

(JPEG image files only)

When you play back JPEG image files as slide show, you can specify the duration for an image to appear on the TV screen.

1 Press  **DISPLAY** repeatedly until the **Control Menu for JPEG image files** appears on the TV screen.

2 Press **↑** or **↓** repeatedly to select  (**INTERVAL**), then press **ENTER**.

The options for “INTERVAL” appear on the TV screen.

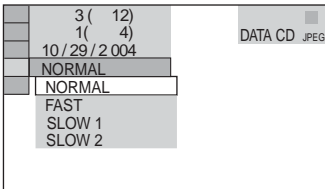

3 Press **↑** or **↓** repeatedly to select the setting you want.

The default setting is underlined.

- NORMAL: Sets the duration to about 6 to 9 seconds (Images that are 4,000,000 pixels or more will lengthen the duration).
- FAST: Sets the duration shorter than NORMAL.
- SLOW 1: Sets the duration longer than NORMAL.
- SLOW 2: Sets the duration longer than SLOW 1.

4 Press **ENTER**.

The selected setting takes effect.

Note

Some JPEG image files (especially progressive JPEG image files or JPEG image files with 3,000,000 pixels or more) may take a longer time to display than others, which may make the duration seem longer than the option you selected.

Selecting a transition effect for image files in the slide show

(JPEG image files only)

When you play back JPEG image files, you can select the transition effect to be used when viewing the slide show.

1 Press  **DISPLAY** repeatedly until the **Control Menu for JPEG image files** appears on the TV screen.

2 Press **↑** or **↓** repeatedly to select  (**EFFECT**), then press **ENTER**.

The options for “EFFECT” appear on the TV screen.

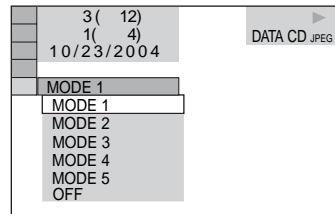

3 Press **↑** or **↓** repeatedly to select the setting you want.

The default setting is underlined.

- MODE 1: The image sweeps in from top to bottom of the screen.
- MODE 2: The image sweeps in from left to right of the screen.
- MODE 3: The image stretches out from the center of the screen.
- MODE 4: The image changes with MODE 1, MODE 2, MODE 3 and some other transition effect randomly.
- MODE 5: The next image slides over the current image.
- OFF: Turns off this function.

4 Press **ENTER**.

The selected setting takes effect.

Using the on-screen display to search for a title/chapter/scene/track/index/album/file

DVD-V

DVD-VR

VIDEO CD

CD

DATA CD

DATA DVD

You can search a title (DVD VIDEO and DVD-R/DVD-RW in VR mode), chapter (DVD VIDEO and DVD-R/DVD-RW in VR mode), track (AUDIO CD, VIDEO CD and MP3 audio tracks), scene (VIDEO CD), index (VIDEO CD), album (MP3 audio tracks and JPEG image files) and file (JPEG image files). As titles, tracks, scenes, albums, chapters, indexes and files are assigned unique numbers on the disc, you can select the number you want from the Control Menu on the TV screen. You can also search for a particular point using the time code (Time Search) (DVD VIDEO and DVD-R/DVD-RW in VR mode only).

1 Press **DISPLAY**. (When playing a DATA CD or DATA DVD with JPEG image files, press **DISPLAY** twice.)

The Control Menu appears on the TV screen.

2 Press **↑** or **↓** repeatedly to select the search item.

- When playing a DVD VIDEO or DVD-R/DVD-RW in VR mode

 TITLE

 CHAPTER

- When playing a VIDEO CD without PBC Playback

 TRACK

 INDEX

- When playing a VIDEO CD or Super VCD with PBC Playback

 SCENE

- When playing an AUDIO CD

 TRACK

- When playing a DATA CD or DATA DVD (MP3 audio track)

 ALBUM

 TRACK

- When playing a DATA CD or DATA DVD (JPEG image file)

 ALBUM

 FILE

Example: when you select  (CHAPTER)

“** (***)” is selected (** refers to a number). The number in parentheses indicates the total number of titles, chapters, tracks, indexes, scenes, albums or files.

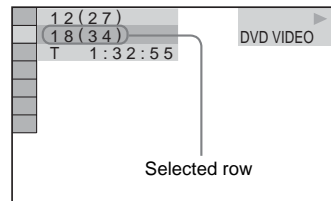

continued

3 Press ENTER.

“** (**)” change to “- - (**)”.

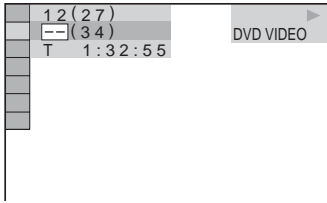

4 Press **↑** or **↓** repeatedly or the numeric buttons to select the title, chapter, track, index, scene, album or file number you want to search.

If you make a mistake, press CLEAR to cancel the number, then select another number.

5 Press ENTER.

The system starts playback from the selected title, chapter, track, index, scene, album or file.

To turn off the Control Menu

Press **DISPLAY** repeatedly until the Control Menu disappears from the TV screen.

Tip

When the Control Menu display is turned off, you can search for a chapter (DVD VIDEO and DVD-R/DVD-RW in VR mode) or track (AUDIO CD and VIDEO CD) by pressing the numeric buttons and ENTER.

To search for a particular point using the time code

— Time Search

DVD-V

DVD-VR

1 Press **DISPLAY**.

The Control Menu appears on the TV screen.

2 Press **↑** or **↓** repeatedly to select **(TIME/TEXT)**.

“T **: **: **” (elapsed playing time of the current title) is selected.

3 Press ENTER.

“T **: **: **” changes to “T--:--:--”.

4 Input the time code using the numeric buttons, then press ENTER.

For example, to find the scene at 2 hours, 10 minutes, and 20 seconds after the beginning, enter “2:10:20”.

If you make a mistake, press CLEAR to cancel the number, then select another number.

Note

Depending on the disc, you cannot perform Time Search.

Tip

You can change the display to show elapsed playing time or remaining time. For details, see “Checking the elapsed playing time, remaining time and titles” on page 68.

Searching by scene

— Picture Navigation

DVD-V VIDEO CD

You can view the first scene of each track (VIDEO CD and Super VCD), each chapter (DVD VIDEO) or each title (DVD VIDEO) so that you can find the track, chapter or title you want quickly.

1 For DVD VIDEO, press PICTURE NAVI repeatedly to select “CHAPTER VIEWER” or “TITLE VIEWER”. For VIDEO CD and Super VCD, press PICTURE NAVI to select “TRACK VIEWER”.

- CHAPTER VIEWER (DVD VIDEO only): displays the first scene of each chapter.
- TITLE VIEWER (DVD VIDEO only): displays the first scene of each title.
- TRACK VIEWER (VIDEO CD and Super VCD only): displays the first scene of each track.

2 Press ENTER.

The first scene of the first 9 chapters, titles or tracks appears on the TV screen as follows:

1	2	3	
4	5	6	
7	8	9	▼

3 Press ↑/↓/←/→ to select a chapter, title or track, then press ENTER.

The system starts playing from the selected scene.

To cancel searching

Press ⏪ RETURN or 📺 DISPLAY.

Notes

- Depending on the disc, you may not be able to select some items.
- During Picture Navigation, “VIEWER” appears in the display.

Tips

- If there are more than 9 chapters, titles, or tracks, “▼” appears at the bottom right of the screen.
- To display the remaining chapters, titles, or tracks, select a scene at the bottom row and press ↓. To return to the previous scene, select a scene at the top row and press ↑.

Disc – Various Functions

Selecting the audio format

DVD-V

DVD-VR

VIDEO CD

CD

DATA CD

DATA DVD

When playing a DVD VIDEO recorded in multiple audio formats, you can select the audio format you want. If the DVD VIDEO is recorded with multilingual tracks, you can also change the language.

When playing a VIDEO CD, AUDIO CD or MP3 audio tracks, you can select the sound from the right or left channel and listen to the sound of the selected channel through both the right and left speakers. For example, when playing a track with the vocals on the right channel and the instruments on the left channel, you can hear the instruments from both speakers by selecting the left channel.

Press AUDIO repeatedly during playback to select the audio signal you want.

The default setting is underlined.

■ When playing a DVD VIDEO

Depending on the DVD VIDEO, the option of language and audio format varies.

When a 4-digit number is displayed, they represent a language code (see “Language code list” on page 90). When the same language is displayed two or more times, the DVD VIDEO is recorded in multiple audio formats.

■ When playing a DVD-R/DVD-RW in VR mode

The number of audio tracks recorded on a disc are displayed.

Example:

- 1: MAIN: the main sound of the audio track 1.
- 1: SUB: the sub sound of the audio track 1.
- 1: MAIN+SUB: the main and sub sound of the audio track 1.
- 2: MAIN: the main sound of the audio track 2.

- 2: SUB: the sub sound of the audio track 2.
- 2: MAIN+SUB: the main and sub sound of the audio track 2.

■ When playing a VIDEO CD, AUDIO CD, or MP3 audio track

- STEREO: the standard stereo sound.
- 1/L: the sound of the left channel (monaural).
- 2/R: the sound of the right channel (monaural).

■ When playing a Super VCD

- 1: STEREO: the stereo sound of the audio track 1.
- 1: 1/L: the sound of the left channel of the audio track 1 (monaural).
- 1: 2/R: the sound of the right channel of the audio track 1 (monaural).
- 2: STEREO: the stereo sound of the audio track 2.
- 2: 1/L: the sound of the left channel of the audio track 2 (monaural).
- 2: 2/R: the sound of the right channel of the audio track 2 (monaural).

Notes

- While playing a DVD-R/DVD-RW in VR mode on which only one audio stream is recorded, “2: MAIN”, “2: SUB” and “2: MAIN+SUB” do not appear.
- While playing a Super VCD on which the audio track 2 is not recorded, no sound will come out when you select “2: STEREO”, “2: 1/L”, or “2: 2/R”.
- You cannot change the sound for DVD VIDEOS that are not recorded in multiple audio format.
- When you play back DVD VIDEOS, the sound may change automatically.

Displaying the audio information of the disc

(DVD VIDEO only)

When you press AUDIO repeatedly during playback, the format of the current audio signal is displayed on the TV screen.

■ When playing a DVD VIDEO

For example, in Dolby Digital format, multiple signals ranging from monaural to 5.1 channel signals can be recorded on a DVD VIDEO. Depending on the DVD VIDEO, the number of recorded channels may differ.

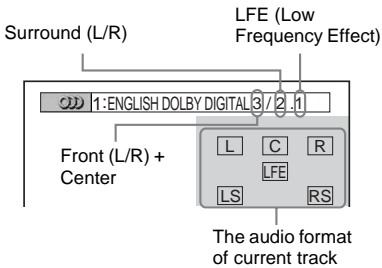

The symbols shown on the TV screen represent the audio signal channels which are output from different speakers.

- L: Front Left
- R: Front Right
- C: Center
- LS: Surround Left
- RS: Surround Right
- S: Surround signal which is produced from Dolby Surround Sound processing or monaural surround audio signal.
- LFE: Low Frequency Effect

Example:

For Dolby Digital 5.1 channel:

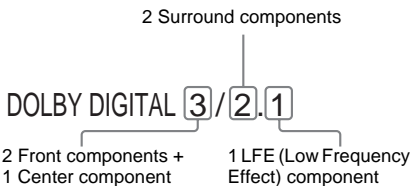

Changing the angles

DVD-V

You can change the viewing angle while playing a DVD VIDEO on which various angles (multi-angles) for a scene are recorded.

For example, while playing a scene of a train in motion, you can display the view from the front of the train, the left window of the train, or from the right window without having the train's movement interrupted.

Press ANGLE repeatedly during playback.

Each time you press ANGLE, the angle changes.

Note

Depending on the DVD VIDEO, you may not be able to change the angle, even if multi-angles are recorded on the DVD VIDEO.

Displaying the subtitles

DVD-V

DVD-VR

You can turn the subtitles on or off while playing a DVD VIDEO or DVD-R/DVD-RW in VR mode on which subtitles are recorded. You can also change the language of the subtitles with DVD VIDEO or DVD-R/DVD-RW in VR mode on which multilingual subtitles are recorded. For example, you can select the language you want and turn the subtitles on for better understanding.

Press SUBTITLE repeatedly during playback.

Each time you press SUBTITLE, the subtitle language changes or turns off.

Notes

- Depending on the DVD VIDEO, you may not be able to change the subtitles even if multilingual subtitles are recorded on the DVD VIDEO. You also may not be able to turn the subtitles off.

Adjusting the delay between the picture and sound

— A/V SYNC

DVD-V DVD-VR VIDEO CD

When the sound does not synchronize with the pictures on the screen, you can adjust the delay between the picture and sound.

- 1 Press **DISPLAY** when playback is stopped.

The Control Menu appears on the TV screen.

- 2 Press **UP** or **DOWN** repeatedly to select **(A/V SYNC)**, then press **ENTER**.

The options for “A/V SYNC” appear on the TV screen.

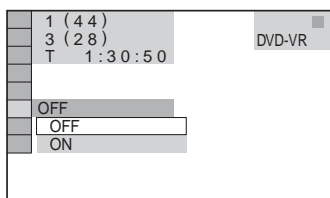

- 3 Press **UP** or **DOWN** repeatedly to select the setting you want.

The default setting is underlined.

- OFF: does not adjust.
- ON: adjusts the difference between picture and sound.

- 4 Press **ENTER**.

Note

Depending on the input stream, this function may not be effective.

Restricting playback of the disc

— CUSTOM PARENTAL CONTROL, PARENTAL CONTROL

DVD-V VIDEO CD C D

You can set 2 kinds of playback restrictions for the disc you want.

- Custom Parental Control
You can set playback restrictions so that the system will not play back inappropriate discs.
- Parental Control
You can limit the playback of some DVD VIDEOS according to a predetermined level such as the age of the users. When a limited scene is played back, that scene may be skipped or replaced with different scenes. The same password is used for both Custom Parental Control and Parental Control.

Preventing playback of specific discs

— CUSTOM PARENTAL CONTROL

You can set the same Custom Parental Control password for up to 40 discs. When you set the 41st-disc, the playback restriction for the first disc is canceled.

- 1 Insert the disc you want to set the playback restriction.

If the disc is playing, press **STOP** to stop playback.

- 2 Press **DISPLAY** when playback is stopped.

The Control Menu appears on the TV screen.

- 3** Press **↑** or **↓** repeatedly to select  (PARENTAL CONTROL), then press ENTER.

The options for “PARENTAL CONTROL” appear on the TV screen.

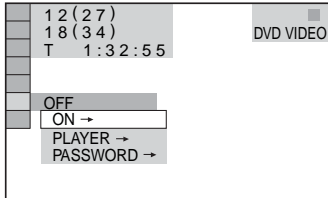

- 4** Press **↑** or **↓** repeatedly to select “ON →”, then press ENTER.

■ **If you have not entered a password**

The display for registering a new password appears on the TV screen.

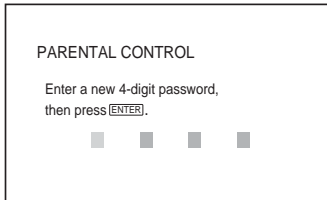

Enter a 4-digit password using the numeric buttons, then press ENTER.

The display for confirming the password appears on the TV screen.

■ **When you have already registered a password**

The display for entering the password appears on the TV screen.

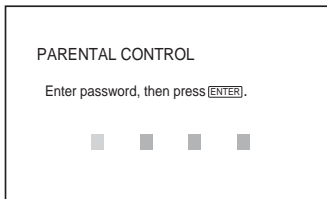

- 5** Enter or re-enter your 4-digit password using the numeric buttons, then press ENTER.

“Custom parental control is set.” appears on the TV screen and the screen returns to the Control Menu.

If you make a mistake entering your password

Press **←** repeatedly to delete the number you have entered, then re-enter your password again.

To turn off the Custom Parental Control function

- 1 Follow steps 1 through 3 of “Preventing playback of specific discs”.
- 2 Press **↑** or **↓** repeatedly to select “OFF →”, then press ENTER.
- 3 Enter your 4-digit password using the numeric buttons, then press ENTER.

To play back a disc for which Custom Parental Control is set

- 1 Insert the disc for which Custom Parental Control is set.

The “CUSTOM PARENTAL CONTROL” display appears on the TV screen.

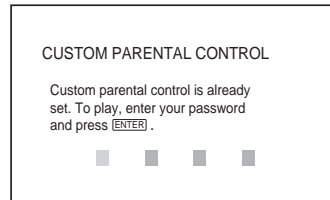

- 2 Enter your 4-digit password using the numeric buttons, then press ENTER.

The system is ready for playback.

Tip

If you forget your password, enter the 6-digit number “199703” using the numeric buttons when the “CUSTOM PARENTAL CONTROL” display asks you for your password, then press ENTER. The display will ask you to enter a new 4-digit password.

Limiting playback for children



— PARENTAL CONTROL

(DVD VIDEO only)

You can limit the playback of some DVD VIDEOS according to a predetermined level such as the age of the users. The “PARENTAL CONTROL” function allows you to set a playback limitation level.



- 1 Press  **DISPLAY** when playback is stopped.

The Control Menu appears on the TV screen.

- 2 Press  or  repeatedly to select  (**PARENTAL CONTROL**), then press **ENTER**.

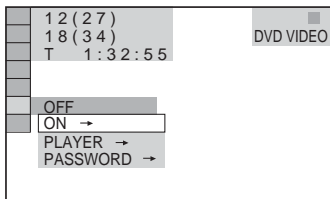
The options for “PARENTAL CONTROL” appear on the TV screen.



- 3 Press  or  repeatedly to select “**PLAYER →**”, then press **ENTER**.

■ If you have not entered a password

The display for registering a new password appears on the TV screen.

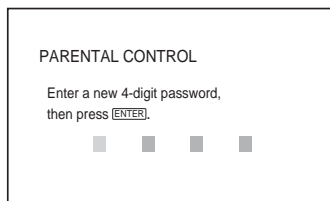

Enter a 4-digit password using the numeric buttons, then press **ENTER**.

The display for confirming the password appears on the TV screen.

■ When you have already registered a password

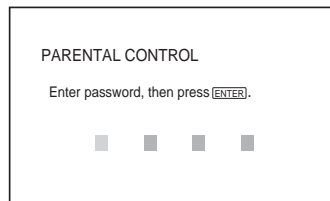

The display for entering the password appears on the TV screen.



- 4 Enter or re-enter your 4-digit password using the numeric buttons, then press **ENTER**.

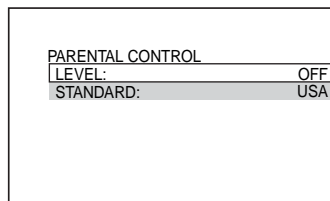

The display for setting the playback limitation level appears on the TV screen.

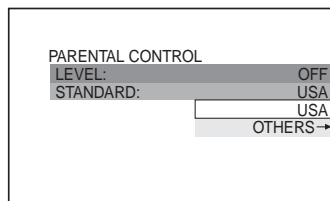

- 5 Press  or  repeatedly to select “**STANDARD**”, then press **ENTER**.

The options for “STANDARD” appear on the TV screen.



- 6 Press  or  repeatedly to select a geographic area as the playback limitation level, then press **ENTER**.

The area is selected.

When you select “OTHERS →”, enter the area code for the geographic area you want according to the “Parental Control Area Code List” on page 39 by using the numeric buttons.

7 Press **↑** or **↓** repeatedly to select “LEVEL”, then press **ENTER**.

The options for “LEVEL” appear on the TV screen.

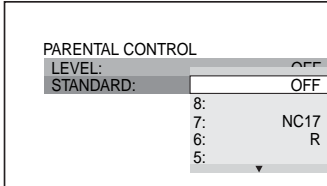

8 Press **↑** or **↓** repeatedly to select the level you want, then press **ENTER**.

Parental Control setting is completed.

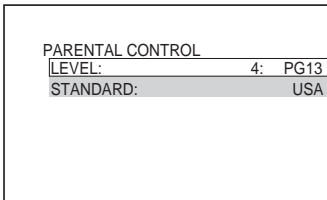

The lower the value, the stricter the limitation.

If you make a mistake entering your password

Press **←** repeatedly to delete the number you have entered, then re-enter your password again.

To turn off the Parental Control function

Set “LEVEL” to “OFF” in Step 8.

To play back a disc for which Parental Control is set

1 Insert the disc and press **▷** (or **◀▶** on the unit).

The display for entering your password appears on the TV screen.

2 Enter your 4-digit password using the numeric buttons, then press **ENTER**.

The system starts playback.

Notes

- The Control Menu display will show different items depending on the disc type.
- When you play back DVD VIDEOS which do not have the Parental Control function, playback cannot be limited on this system.
- Depending on the DVD VIDEO, you may be asked to change the parental control level while playing the disc. In this case, enter your password, then change the level. If Resume Play is canceled, the level returns to the original level.







Tip

If you forget your password, remove the disc and repeat steps 1 to 3 of “Limiting playback for children”. When you are asked to enter your password, enter “199703” using the numeric buttons, then press **ENTER**. The display will ask you to enter a new 4-digit password. After you enter a new 4-digit password, reload the disc and press **▷** (or **◀▶** on the unit). When the display for entering your password appears, enter your new password.

Parental Control Area Code List

Area	Code number	Area	Code number
Argentina	2044	Mexico	2362
Australia	2047	Netherlands	2376
Austria	2046	New Zealand	2390
Belgium	2057	Norway	2379
Brazil	2070	Pakistan	2427
Canada	2079	Philippines	2424
Chile	2090	Portugal	2436
China	2092	Russia	2489
Denmark	2115	Singapore	2501
Finland	2165	Spain	2149
France	2174	Sweden	2499
Germany	2109	Switzerland	2086
India	2248	Thailand	2528
Indonesia	2238	United Kingdom	2184
Italy	2254		
Japan	2276		
Korea	2304		
Malaysia	2363		

Changing the password

- 1 Press  **DISPLAY** when playback is stopped.
The Control Menu appears on the TV screen.
- 2 Press  or  repeatedly to select  (**PARENTAL CONTROL**), then press **ENTER**.
The options for “PARENTAL CONTROL” appear on the TV screen.
- 3 Press  or  repeatedly to select “**PASSWORD →**”, then press **ENTER**.
The display for entering the password appears on the TV screen.
- 4 Enter your 4-digit password using the numeric buttons, then press **ENTER**.
- 5 Enter a new 4-digit password using the numeric buttons, then press **ENTER**.
- 6 To confirm your password, re-enter it using the numeric buttons, then press **ENTER**.

If you make a mistake entering your password

Press  repeatedly to delete the number you have entered, then re-enter your password again.



Using the DVD setup menu

By using the DVD setup menu, you can make various adjustments to items such as picture and sound. For details on each DVD setup menu item, see pages 41–47. For an overall list of DVD setup menu items, see page 89.

Note



Playback settings stored in the disc take priority over the DVD setup menu settings. Therefore, some of the DVD setup menu settings may not be performed.

- 1 Press  **DISPLAY** when playback is stopped.
The Control Menu appears on the TV screen.

- 2 Press  or  repeatedly to select  (**SETUP**), then press **ENTER**.

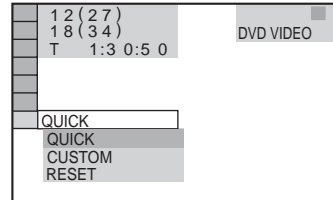

The options for “SETUP” appear on the TV screen.

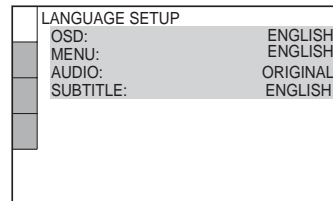

- 3 Press  or  repeatedly to select “**CUSTOM**”, then press **ENTER**.

The Setup menu appears on the TV screen.



- 4 Press  or  repeatedly to select the setup item from the displayed list: “**LANGUAGE SETUP**”, “**SCREEN SETUP**”, “**CUSTOM SETUP**”, or “**SPEAKER SETUP**”. Then press **ENTER**.

The setup item is selected.

Example: **SCREEN SETUP**

Selected item

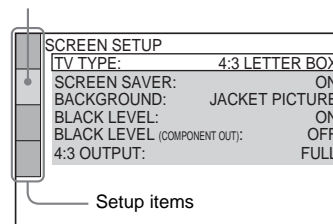

Setup items

- 5** Press **↑** or **↓** repeatedly to select the item you want, then press **ENTER**.

The options for the selected item appear on the TV screen.

Example: TV TYPE

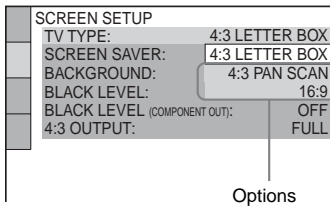

- 6** Press **↑** or **↓** repeatedly to select the setting you want, then press **ENTER**.

The setting is selected and setup is completed.

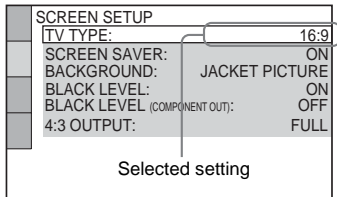

■ OSD (On-Screen Display)

Switches the language of the on-screen display.

■ MENU (DVD VIDEO only)

Select the language for the DVD menu.

■ AUDIO (DVD VIDEO only)

Switches the language of the sound track.

When you select “ORIGINAL”, the language given priority in the disc is selected.

■ SUBTITLE (DVD VIDEO only)

Switches the language of the subtitle .

When you select “AUDIO FOLLOW”, the language for the subtitles changes according to the language you selected for the sound track.

Note

When you select a language in “MENU”, “SUBTITLE”, or “AUDIO” that is not recorded on the DVD VIDEO, one of the recorded language is automatically selected. However, depending on the disc, the language may not be selected automatically.

Tip

If you select “OTHERS →” in “MENU”, “SUBTITLE”, and “AUDIO”, enter a language code from the “Language code list” (page 90) using the numeric buttons.

Setting the language

— LANGUAGE SETUP

“LANGUAGE SETUP” allows you to set various languages for the on-screen display or sound track.

Select “LANGUAGE SETUP” in the Setup menu. For details, see “Using the DVD setup menu” (page 40).

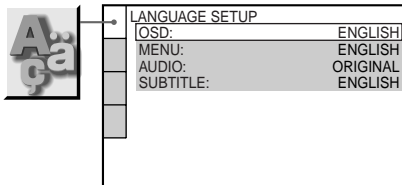

Setting the TV screen

— SCREEN SETUP

Choose the settings according to the TV you connected.

Select “SCREEN SETUP” in the Setup menu. For details, see “Using the DVD setup menu” (page 40).

The default settings are underlined.

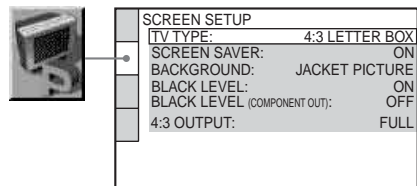

continued

■ TV TYPE (DVD VIDEO only)

Selects the aspect ratio of the connected TV (4:3 standard or wide).

The default setting varies depending on the country.

4:3 LETTER BOX Select this when you connect a 4:3 screen TV. This setting displays a wide picture with bands on the upper and lower portions of the screen.

4:3 PAN SCAN Select this when you connect a 4:3 screen TV. This setting displays the wide picture on the entire screen and cuts off the portions that do not fit.

16:9 Select this when you connect a wide-screen TV or a TV with a wide mode function.

4:3 LETTER BOX



4:3 PAN SCAN

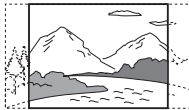

16:9



Note

Depending on the DVD VIDEO, “4:3 LETTER BOX” may be selected automatically instead of “4:3 PAN SCAN” or vice versa.

■ SCREEN SAVER

Turn on or off the screen saver. If you turn on the screen saver, the screen saver image appears when playback is stopped or paused for 15 minutes or when you play back an AUDIO CD or MP3 audio tracks for more than 15 minutes. The screen saver will help prevent your display device from becoming damaged (ghosting). Press \triangleright (or $\blacktriangleleft\blacktriangleright$ on the unit) to turn off the screen saver.

ON Turns on the screen saver.

OFF Turns off the screen saver.

■ BACKGROUND

Selects the background color or picture to be displayed on the TV screen. The background color or picture is displayed when playback is stopped or while playing an AUDIO CD and MP3 audio tracks.

JACKET PICTURE The jacket picture (still picture) appears in the background, but only when the jacket picture is already recorded on the disc (DVD VIDEO, CD-EXTRA, etc.). If the disc does not contain a jacket picture, the “GRAPHICS” picture appears.

GRAPHICS A preset picture stored in the system appears in the background.

BLUE The background color is blue.

BLACK The background color is black.

■ BLACK LEVEL

Select the black level (setup level) for the video signals output from the video jacks other than COMPONENT VIDEO OUT jacks.

ON Set the black level of the output signal to the standard level.

OFF Lower the standard black level. Use this when the picture becomes too white.

■ BLACK LEVEL (COMPONENT OUT)

Select the black level (setup level) for the video signals output from the COMPONENT VIDEO OUT jacks. You cannot select “BLACK LEVEL (COMPONENT OUT)” when the system outputs progressive signal.

OFF	Set the black level of the output signal to the standard level.
ON	Raise the standard black level. Use this when the picture becomes too black.

■ 4:3 OUTPUT

This setting is effective only when you set “TV TYPE” in “SCREEN SETUP” to “16:9” (page 42). Change this setting to watch 4:3 aspect ratio progressive signals. If you can change the aspect ratio on your progressive format (525p/625p) compatible TV, change the setting on your TV.

Note

This setting is effective only when “P AUTO” or “P VIDEO” is selected. Press PROGRESSIVE on the unit repeatedly to select “P AUTO” or “P VIDEO”.

FULL	Select this when you can change the aspect ratio on your TV.
NORMAL	Select this when you cannot change the aspect ratio on your TV. Shows a 16:9 aspect ratio signal with black bands on left and right sides of the image.

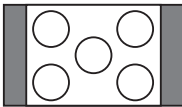

16:9 aspect ratio TV

Setting playback options**— CUSTOM SETUP**

Use this to set up playback related and other settings.

Select “CUSTOM SETUP” in the Setup menu. For details, see “Using the DVD setup menu” (page 40).

The default settings are underlined.

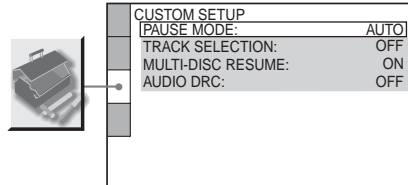
**■ PAUSE MODE (DVD VIDEO and DVD-R/DVD-RW in VR mode only)**

Select the picture in pause mode.

AUTO	The picture, including subjects that move dynamically, is output with no jitter. Normally select this position.
FRAME	The picture, including subjects that do not move dynamically, is output in high resolution.

■ TRACK SELECTION (DVD VIDEO only)

Gives priority to the sound track which contains the highest number of channels when you play back a DVD VIDEO on which multiple audio formats (PCM, DTS, MPEG audio, or Dolby Digital format) are recorded.

OFF	No priority given.
AUTO	Priority given.

Notes

- When you set “TRACK SELECTION” to “AUTO”, the language may change. The “TRACK SELECTION” setting has higher priority than the “AUDIO” settings in “LANGUAGE SETUP” (page 41). However, depending on the disc, this function may not be performed.
- If PCM, DTS, Dolby Digital, and MPEG audio sound tracks have the same number of channels, the system selects PCM, DTS, Dolby Digital, and MPEG audio sound tracks in this order.

■ MULTI-DISC RESUME (DVD VIDEO and VIDEO CD only)

Turns on and off the Multi-Disc Resume function. The resume playback point can be stored in the memory for up to 40 different DVD VIDEOS or VIDEO CDs (page 19).

ON	Stores the resume playback point in the memory for up to 40 discs.
OFF	Does not store the resume playback point in the memory. Playback starts at the resume playback point only for the current disc in the system.

■ AUDIO DRC (Dynamic Range Compression) (DVD VIDEO and DVD-R/ DVD-RW in VR mode only)

Narrows the dynamic range of the sound track. Useful for watching movies at low volume late at night.

OFF	No compression of dynamic range.
STANDARD	Reproduces the sound track with the kind of dynamic range that the recording engineer intended.
MAX	Narrows the dynamic range fully.

Note

AUDIO DRC can only be performed with Dolby Digital sources.

Setting the speakers

— SPEAKER SETUP

To obtain the best possible surround sound, set the size of the speakers you have connected and their distance from your listening position. Then, use the test tone to adjust the level of the speakers to the same level.

Select “SPEAKER SETUP” in the Setup menu. For details, see “Using the DVD setup menu” (page 40).

The default settings are underlined.

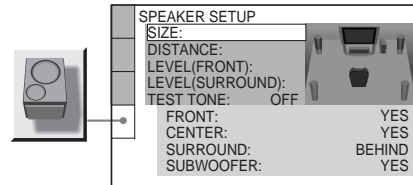

To return to the default setting when changing a setting

Press CLEAR before you press ENTER.

However, note that you cannot return the setting of “SIZE” to default setting.

Note

You cannot perform SPEAKER SETUP when you connect headphones or microphones to the unit.

■ SIZE

When you connect or disconnect the center speaker, surround speakers or subwoofer or when you move the surround speakers, change the setting for CENTER, SURROUND and SUBWOOFER. Since the front speaker setting is fixed, you cannot change them.

Position diagram

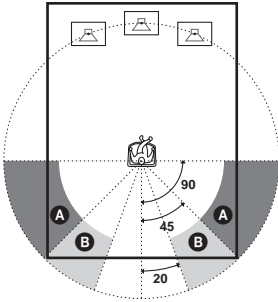

FRONT	<u>YES</u>
CENTER	<u>YES</u> : Normally select this. <u>NONE</u> : Select this if the center speaker is not connected.
SURROUND	<u>BEHIND</u> : Select this if the surround speakers are located in section B . <u>SIDE</u> : Select this if the surround speakers are located in section A . <u>NONE</u> : Select this if the surround speakers are not connected.
SUBWOOFER	<u>YES</u> : Normally, select this (FST-ZX100D/LBT-ZX100D/MHC-GN1000D only). Select this if you have connected an optional sub woofer (FST-ZX80D/LBT-ZX80D only). <u>NONE</u> : Select this if the subwoofer is not connected (FST-ZX100D/LBT-ZX100D/MHC-GN1000D only). Select this if an optional sub woofer is not connected (FST-ZX80D/LBT-ZX80D only).

Notes

- When you change the setting, the sound cuts off for a moment.
- Depending on the settings of other speakers, the subwoofer may output excessive sound.
- When you play back a DVD VIDEO that does not have subwoofer output recorded, no sound is output from the subwoofer, even if “SUBWOOFER” is set to “YES”.

■ **DISTANCE**

The default distance setting for the speakers in relation to the listening position is shown below. When you set the distance using QUICK SETUP (page 14), the settings are automatically displayed. The items that are set to “NONE” in “SIZE” cannot be selected.

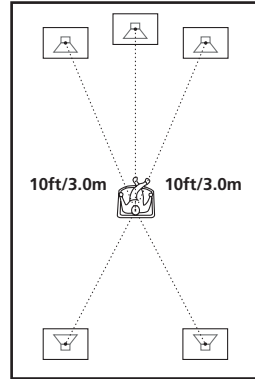

Be sure to change the value in the Setup menu when you move the speakers.

FRONT <u>10ft 3.0m</u> ¹⁾	Front speaker distance from the listening position can be set in 1 foot (0.2 meter) increments from 3 to 23 feet (0.9 to 6.9 meters).
CENTER <u>10ft 3.0m</u> ¹⁾²⁾	Center speaker distance from the listening position can be set in 1 foot (0.2 meter) increments from 0 to 23 feet (0.0 to 6.9 meters).
SURROUND <u>10ft 3.0m</u> ¹⁾²⁾	Surround speaker distance from the listening position can be set in 1 foot (0.2 meter) increments from 0 to 23 feet (0.0 to 6.9 meters).

- 1) When you perform QUICK SETUP (page 14), the default settings are changed.
- 2) The setting range changes depending on the front speaker setting.

Notes

- When you adjust the speaker distance, the sound may cut off for a moment.
- If each front and surround speakers are not placed at an equal distance from your listening position, set the distance according to the closest speaker.
- Do not place the surround speakers further away from your listening position than the front speakers.
- Depending on the input stream, the “DISTANCE” setting may not be effective.

continued

■ LEVEL (FRONT)

You can adjust the level of the front speakers, center speaker and subwoofer as follows. Be sure to set “TEST TONE” to “ON” for easy adjustment. The items that are set to “NONE” in “SIZE” cannot be selected.

L 0.0 dB	Set this between -6.0 dB and 0.0 dB in 1.0 dB increments.
R 0.0 dB	Set this between -6.0 dB and 0.0 dB in 1.0 dB increments.
CENTER 0.0 dB	Set this between -6.0 dB and +6.0 dB in 1.0 dB increments.
SUBWOOFER 0.0 dB	Set this between -6.0 dB and +6.0 dB in 1.0 dB increments (FST-ZX100D/LBT-ZX100D/MHC-GN1000D only). Set this between -10.0 dB and +10.0 dB in 1.0 dB increments (FST-ZX80D/LBT-ZX80D only).

Depending on the sub woofer, the sound output may be smaller compared to other speakers when you adjust the “SUBWOOFER” setting during test tone.

■ LEVEL (SURROUND)

You can adjust the level of each surround speakers as follows. Be sure to set “TEST TONE” to “ON” for easy adjustment. This setting cannot be selected when “SURROUND” is set to “NONE” in the “SIZE” setting.

L 0.0 dB	Set this between -6.0 dB and +6.0 dB in 1.0 dB increments.
R 0.0 dB	Set this between -6.0 dB and +6.0 dB in 1.0 dB increments.

Tip

To adjust the volume of all speakers at the same time, press VOLUME +/- repeatedly (or turn MASTER VOLUME on the unit).

















■ TEST TONE

The speakers will emit a test tone to adjust “LEVEL (FRONT)” and “LEVEL (SURROUND)”.

OFF	The test tone is not emitted from the speakers.
------------	---

ON	The test tone is emitted from each speaker in sequence (FST-ZX100D/LBT-ZX100D/MHC-GN1000D only). The test tone is emitted from each speaker in sequence except for subwoofer (FST-ZX80D/LBT-ZX80D only). The test tone is emitted from the selected speakers when you select “LEVEL (FRONT)” or “LEVEL (SURROUND)”.
-----------	---

Adjusting the speaker level by using the test tone

- 1 Press**  **DISPLAY** when playback is stopped.
The Control Menu appears on the TV screen.
- 2 Press**  or  repeatedly to select  (**SETUP**), then press **ENTER**.
The options for “SETUP” appear on the TV screen.
- 3 Press**  or  repeatedly to select “**CUSTOM**”, then press **ENTER**.
The Setup menu appears on the TV screen.
- 4 Press**  or  repeatedly to select “**SPEAKER SETUP**”, then press **ENTER**.
- 5 Press**  or  repeatedly to select “**TEST TONE**”, then press **ENTER**.
- 6 Press**  or  repeatedly to select “**ON**”, then press **ENTER**.
For FST-ZX100D, LBT-ZX100D and MHC-GN1000D, you will hear the test tone from each speaker in sequence.
For FST-ZX80D and LBT-ZX80D, you will hear the test tone from each speaker in sequence except for subwoofer.
- 7 Press**  or  repeatedly to select “**LEVEL (FRONT)**”, then press **ENTER**.
- 8 Press**  or  repeatedly to select the speaker, then press **ENTER**.
The test tone is emitted from the selected speaker.

- 9** Press **↑** or **↓** repeatedly to adjust the level from your listening position.
- 10** Press **ENTER** when you have finished making the adjustment.
- 11** Repeat steps 8 to 10 to adjust the speaker level for other speakers.
- 12** Press **←**.
- 13** Press **↑** or **↓** repeatedly to select “LEVEL (SURROUND)”, then press **ENTER**.
- 14** Repeat steps 8 to 11 to adjust the speaker level for other speakers.
- 15** Press **←**.
- 16** Press **↑** or **↓** repeatedly to select “TEST TONE”, then press **ENTER**.
- 17** Press **↑** or **↓** repeatedly to select “OFF”, then press **ENTER**.

Note

When you adjust the speaker settings, the sound may cut off for a moment.

Tip

To adjust the volume of all speakers at the same time, press **VOLUME +/-** repeatedly (or turn **MASTER VOLUME** on the unit).

Tuner**Presetting radio stations**

You can preset up to 20 FM stations and 10 AM stations. You can then tune in any of those stations simply by selecting the corresponding preset number.

Automatic tuning preset

You can automatically tune in all of the stations that can be received in your area and then store the frequency of your favourite stations manually.

- 1** Press **FUNCTION +/-** repeatedly to select “TUNER FM” or “TUNER AM” (or press **TUNER/BAND** on the unit repeatedly to select “FM” or “AM”).
- 2** Press and hold **TUNING +/-** until the frequency indication starts to change and then release.

“AUTO” lights up in the display. Scanning stops automatically when a station is tuned in and “TUNED” lights up in the display. When a FM stereo program is tuned in, “STEREO” lights up in the display.

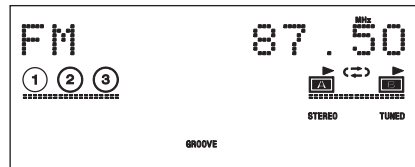
**If “TUNED” does not light up and the scanning does not stop**

Set the frequency of the radio station you want as described in step 2 of “Manual tuning preset”.

- 3** Press **MENU**.
“Memory?” flashes in the display.

4 Press ENTER.

A preset number flashes in the display.
The stations are stored from preset number 1.



5 Press PRESET +/- repeatedly to select the preset number you want.

6 Press ENTER.

“Complete!” appears in the display. The station is stored.

7 Repeat steps 1 to 6 to store other stations.

Manual tuning preset

You can manually tune in and store the frequency of your favourite stations.

1 Press FUNCTION +/- repeatedly to select “TUNER FM” or “TUNER AM” (or press TUNER/BAND on the unit repeatedly to select “FM” or “AM”).

2 Press TUNING +/- repeatedly to tune in the station you want.

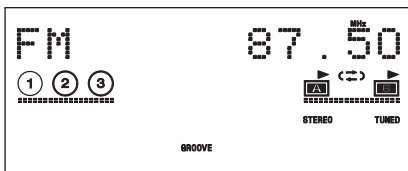

3 Press MENU.

“Memory?” flashes in the display.

4 Press ENTER.

A preset number flashes in the display.
The stations are stored from preset number 1.



5 Press PRESET +/- repeatedly to select the preset number you want.

6 Press ENTER.

“Complete!” appears in the display. The station is stored.

7 Repeat steps 1 to 6 to store other stations.

Other operations

To	Do this
Tune in a station with a weak signal	Follow the procedure described in “Manual tuning preset” (page 48).
Stop scanning during automatic tuning	Press ■.
Cancel presetting	Press MENU.

To change the AM tuning interval

The factory setting for AM tuning interval is 10 kHz.

Use the buttons on the unit for the operation.

1 Press TUNER/BAND repeatedly to select “AM”.

2 Press I/⏻ to turn off the system.

3 Hold down ENTER and then press I/⏻ to turn on the system.

“AM 9k STEP” or “AM 10k STEP” appears in the display.

When you change the interval, all the AM preset stations are erased. To reset the interval, repeat the same procedure.

Note

You cannot change the AM tuning interval in Power Saving Mode (page 66).

Tips

- The preset stations are retained for half a day even if you unplug the power cord or if a power failure occurs.
- If you press TUNER/BAND on the unit while the system is turned off, the system turns on automatically and “TUNER” is selected as the function except during Power Saving Mode.

Listening to the radio

You can listen to a radio station either by selecting a preset station, or by manually tuning in the station.

Listening to a preset radio station

— Preset Tuning

Before tuning to preset stations, be sure to preset them first (see “Presetting radio stations” on page 47).

- 1 Press FUNCTION +/- repeatedly to select “TUNER FM” or “TUNER AM” (or press TUNER/BAND on the unit repeatedly to select “FM” or “AM”).**
- 2 Press PRESET +/- repeatedly to select the preset station you want.**

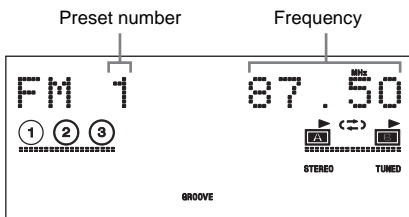

Listening to a non-preset radio station

— Manual Tuning

- 1 Press FUNCTION +/- repeatedly to select “TUNER FM” or “TUNER AM” (or press TUNER/BAND on the unit repeatedly to select “FM” or “AM”).**
- 2 Press TUNING +/- repeatedly to tune in the station you want.**

Tips

- For Preset Tuning, you can use the numeric buttons to select a preset station. Press the numeric button(s) to enter the preset number and then press ENTER.
- To improve broadcast reception, adjust the supplied antennas, or connect an external antenna.
- When an FM stereo program has static noise, press FM MODE repeatedly until “MONO” lights up in the display. There will be no stereo effect, but the reception will improve.
- To record the radio programs, see “Recording onto a tape manually” (page 51) or “Timer recording radio programs” (page 65).

Tape – Playback

Loading a tape

- 1 Push \rightarrow (\triangle A) or \leftarrow (B \triangle) on the unit according to its direction to open the selected deck.

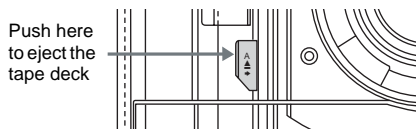

- 2 Load a tape into Deck A or B.

With the side you want to play back or record facing forward

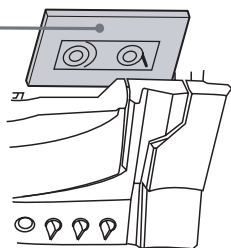

- 3 Push the center of the tape lid to close the deck.

Playing a tape

You can use TYPE I (normal) tape.

- 1 Load a tape.
- 2 Press FUNCTION +/- (or TAPE A/B on the unit) repeatedly to select "TAPE A" or "TAPE B".
- 3 Press DIRECTION on the unit repeatedly to select " \rightleftarrows " to play back one side, " \rightleftarrows "¹ to play back both sides or "RELAY"² (Relay Play) to play back both decks in succession.

- 4 Press \triangleright (or \blacktriangleleft on the unit).

The tape starts playing.

Press \triangleright (or \blacktriangleleft on the unit) again to play back the reverse side.

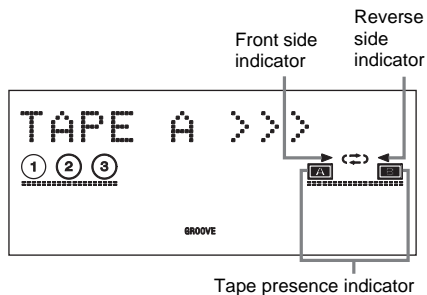

- 1) The playback stops automatically after repeating the sequence five times.
- 2) Relay Play follows this cyclic sequence up to five times, then stops:
Deck A (front side) \rightarrow Deck A (reverse side)
 \rightarrow Deck B (front side) \rightarrow Deck B (reverse side)

Other operations

To	Do this
Stop playback	Press \blacksquare .
Pause playback	Press \parallel . Press \parallel again to resume playback.
Fast-forward or rewind	Press \blacktriangleleft or \blacktriangleright (or $\blacktriangleleft\blacktriangleleft$ or $\blacktriangleright\blacktriangleright$ on the unit). To return to normal playback, press \triangleright (or \blacktriangleleft on the unit).
Remove a tape	Push \rightarrow (\triangle A) or \leftarrow (B \triangle) on the unit according to its direction when playback is stopped.

Note

Do not push \rightarrow (\triangle A) or \leftarrow (B \triangle) on the unit while playing a tape, otherwise the tape could be damaged.

Tips

- When a tape is inserted, the corresponding presence indicator lights up in the display.
- If you press TAPE A/B on the unit while the system is turned off, the system turns on automatically and "TAPE A" or "TAPE B" is selected as the function except during Power Saving Mode.
- If you press \triangleright (or \blacktriangleleft on the unit) when the TAPE A function is selected and there is no tape in Deck A, the system automatically switches to the TAPE B function when there is a tape in Deck B and vice versa. Then, playback will start.

Tape – Recording

Recording your favorite disc onto a tape



— CD Synchro Recording

VIDEO CD

CD

You can record a whole disc onto a tape. You can use TYPE I (normal) tape. The recording level is adjusted automatically.

Use the buttons on the unit for the operation.

- 1 Load a recordable tape into Deck B.**
- 2 Press DVD and load a disc you want to record.**
- 3 Press CD SYNC.**
“SYNC” lights up in the display and “REC” flashes in the display.
Deck B stands by for recording.
- 4 Press DIRECTION repeatedly to select “” to record on one side or “” (or “RELAY”) to record on both sides.**
- 5 Press REC PAUSE/START.**
“REC” lights up in the display.
Recording starts.

To stop recording



Press .

Notes

- You cannot listen to other sources while recording.
- When you press CD SYNC, the sound field is automatically changed to LINK if the current sound field is SBS MULTI, A.F.D. AUTO, PRO LOGIC, PLII MOVIE, PLII MUSIC, V.M.DIM or 2CH STEREO and to HP 2CH if the current sound field is HP VIRTUAL.
- CD Synchro Recording stops when the current disc finishes playback.
- The CD Synchro Recording function cannot perform under the following conditions:
 - During playback of the disc.
 - When the display for entering the password appears on the TV screen during Custom Parental Control function.
 - Before the system finishes reading the Table of Contents (TOC) of the disc.

- When CD Synchro Recording starts,
 - the setting for Repeat Play changes to “REPEAT OFF”.
 - Program Play and Shuffle Play is canceled.
- When you record from a VIDEO CD, PBC playback is automatically canceled.
- If you connect or disconnect a microphone or headphone during recording, the sound may cut off for a moment.

Tips

- When recording from the reverse side:
After step 1 of “Recording your favorite disc onto a tape” (page 51), press TAPE A/B repeatedly until “TAPE B” appears in the display. Press  repeatedly until the TAPE B reverse side indicator lights up to start playback of the reverse side. Press  at the point you want to start recording.
- When recording on both sides:
Be sure to start from the front side. If you start from the reverse side, recording stops at the end of the reverse side.



Recording onto a tape manually

— Manual Recording

You can record just the portions you like from a disc, tape or radio program onto a tape.

You can also record from connected components (see “Hooking up optional components” on page 71).

Use the buttons on the unit for the operation.

- 1 Load a recordable tape into Deck B.**
- 2 Press DVD, TUNER/BAND, TAPE A/B, TV/SAT or VIDEO to select the source you want to record.**
- 3 Load the disc, tape or tune to the station you want to record. To record from the connected component, connect the external audio sources.**
- 4 Press REC PAUSE/START.**
“REC” flashes in the display.
Deck B stands by for recording.
- 5 Press DIRECTION repeatedly to select “” to record on one side or “” (or “RELAY”) to record on both sides.**

continued

6 Press REC PAUSE/START.

“REC” lights up in the display.
Recording starts.

7 Start playing the source to be recorded.

To stop recording

Press ■.

Notes

- When you press REC PAUSE/START, the sound field is automatically changed to LINK if the current sound field is SBS MULTI, A.F.D. AUTO, PRO LOGIC, PLII MOVIE, PLII MUSIC, V.M.DIM or 2CH STEREO and to HP 2CH if the current sound field is HP VIRTUAL.
- You cannot listen to other sources while recording.

Tips

- When recording from the reverse side:
After step 1 of “Recording onto a tape manually” (page 51), press TAPE A/B repeatedly until “TAPE B” appears in the display. Press ◀▶ repeatedly until the TAPE B reverse side indicator lights up to start playback of the reverse side. Press ■ at the point you want to start recording.
- When recording on both sides:
Be sure to start from the front side. If you start from the reverse side, recording stops at the end of the reverse side.
- When recording from the radio:
If noise is heard while recording from the radio, move the respective antenna to reduce the noise.
- When recording from a disc onto a tape manually:
You can press ◀◀ or ▶▶ repeatedly to select the tracks during recording pause mode (after step 4 and before step 6 of “Recording onto a tape manually” (page 51)).
- When recording from the tape:
If you set the direction to “↔” (or “RELAY”) when the tapes you use have different lengths, the tape in each deck reverses independently.

Sound Adjustment

Adjusting the sound

You can reinforce the bass and create a more powerful sound.

The GROOVE setting is ideal for music sources, and the V-GROOVE setting is ideal for video sources (movie, etc.).

Press GROOVE on the unit repeatedly.

Each time you press the button, the display changes cyclically as follows:

GROOVE ON* → V-GROOVE ON* → GROOVE OFF

* The volume switches to power mode and the equalizer curve changes.

Tips

- The default setting is “GROOVE ON”.
- “GROOVE” lights up in the display if “GROOVE ON” is selected.
- “V-GROOVE” lights up in the display if “V-GROOVE ON” is selected.

Selecting the preset effect

Use the buttons on the unit for the operation.

Turn OPERATION DIAL clockwise or counterclockwise to select the preset effect you want.

Preset effect options

Effect	Category
ROCK	Standard music sources
POP	
JAZZ	
DANCE	
SOUL	
TECHNO	
HIP HOP	
MP3 EQ	MP3 audio tracks
FLAT	Original music source
USER EQ 1	User equalizer setting
USER EQ 2	
USER EQ 3	

To cancel the preset effect

Turn OPERATION DIAL clockwise or counterclockwise until “FLAT” appears in the display.

Note

To store the user equalizer setting, see “Adjusting the graphic equalizer and storing the user equalizer setting” on page 53.

Adjusting the graphic equalizer and storing the user equalizer setting

You can adjust the sound by raising or lowering the level of specific frequency band, then store up to three user equalizer settings in the memory.

Use the buttons on the unit for the operation.

- 1 Press EQ BAND repeatedly to select a frequency band.
- 2 Turn OPERATION DIAL clockwise or counterclockwise to adjust the level.

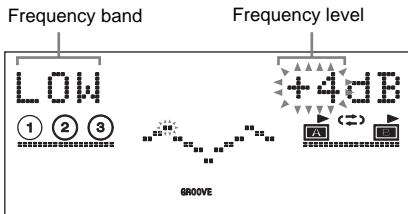

- 3 Repeat steps 1 and 2 to adjust the level of other frequency bands.
- 4 Press ENTER.
A user equalizer number flashes in the display.
- 5 Turn OPERATION DIAL clockwise or counterclockwise to select a user equalizer number (1~3) you want to store the equalizer setting.

- 6 Press ENTER.

This setting is automatically stored as the user equalizer setting you selected in step 5. The previous setting stored at this memory location is erased and replaced by the new setting.

To cancel storing

Turn OPERATION DIAL clockwise or counterclockwise in step 5 to select “EXIT?”, then press ENTER.

To call up a user equalizer setting

Turn OPERATION DIAL clockwise or counterclockwise until the user equalizer setting number you want appears in the display.

Selecting the sound field

You can take advantage of the surround sound simply by selecting one of the sound fields. They bring the exciting and powerful sound of movie theaters into your home.

- 1 Press SOUND FIELD.
The last selected sound field appears in the display.
- 2 Press \uparrow/\downarrow or \leftarrow/\rightarrow repeatedly (or turn OPERATION DIAL on the unit clockwise or counterclockwise) when the last selected sound field appears in the display to select the sound field you want.

The display changes as follows:

■ When the headphones are not connected
 SBS MULTI¹⁾ \leftrightarrow A.F.D. AUTO¹⁾ \leftrightarrow
 PRO LOGIC¹⁾ \leftrightarrow PLII MOVIE¹⁾ \leftrightarrow
 PLII MUSIC¹⁾ \leftrightarrow V.M.DIM.¹⁾ \leftrightarrow
 LINK \leftrightarrow 2CH STEREO

■ When the headphones are connected
 HP 2CH \leftrightarrow HP VIRTUAL¹⁾

¹⁾These sound fields cannot be selected when:

- the system is in standby for recording or during recording.
 - a microphone is connected.
 - the Karaoke Mode is turned on.
- **SBS MULTI (Sound Broadcasting System Multi mode):**
Performs suitable decoding based on the source to maximize the sound field effect. This mode lets you enjoy audio playback of all types of discs from multiple speakers.
 - **A.F.D. AUTO (Auto Format Direct Auto):**
The number of sound channels depends on the source. During DVD function, when 2 channel sources such as AUDIO CD, VIDEO CD and MP3 audio tracks are played back, only 2 sound channels would be output. However, the number of sound channels output during DVD VIDEO playback would depend on the audio format selection. During other functions, the system would only output 2 sound channels. This setting is ideal when you want to listen to the original sound from the source.
 - **PRO LOGIC:**
Performs Pro Logic decoding. The source recorded in 2 channels is decoded into 4.1 channels.
 - **PLII MOVIE:**
Performs Pro Logic II Movie mode decoding. This setting is ideal for movies encoded in Dolby Surround. In addition, this mode can reproduce sound in 5.1 channels when watching videos of overdubbed or old movies. The source recorded in 2 channels is decoded into 5.1 channels.
 - **PLII MUSIC:**
Performs Pro Logic II Music mode decoding. This setting is ideal for normal stereo sources such as AUDIO CDs. The source recorded in 2 channels is decoded into 5.1 channels.
 - **V.M.DIM.:**
Performs DCS (Digital Cinema Sound) decoding. The source recorded in 2 channels is decoded into 5.1 channels.
 - **LINK:**
Reproduces the surround channels from the front channels.

- **2CH STEREO:**

Reproduces stereo output from multi channel sources such as DVD VIDEOS during DVD function. The system outputs the original sound during functions other than DVD and during playback of stereo sources such as AUDIO CD, VIDEO CD and MP3 audio tracks.

- **HP 2CH:**

The normal sound field for headphones.

- **HP VIRTUAL:**

The sound field for headphones with virtual surround effect. This sound field is only effective when you play back multi channel sources.

Notes

- Depending on the disc, the surround effect may not be as much as expected.
- You can also press SOUND FIELD repeatedly to select the sound field you want.

Tips

- “PRO LOGIC” lights up in the display when Pro Logic decoding is performed.
- “PRO LOGIC II” lights up in the display when Pro Logic II Movie/Music mode decoding is performed.
- “LINK” lights up in the display when “LINK” is selected.
- “VIRTUAL” lights up in the display when “HP VIRTUAL” is selected.
- “VIRTUAL” and “DCS” light up in the display when “V.M.DIM.” is selected.

Using the subwoofer

(FST-ZX100D/LBT-ZX100D/ MHC-GN1000D only)

You can use the subwoofer to enhance the bass.

1 Press **SUBWOOFER ON/OFF** on the subwoofer repeatedly until the indicator lights up.

The subwoofer is turned on.

You will be able to listen to low bass frequency sound.

2 Turn **SUBWOOFER LEVEL** to adjust the level.

To turn off the subwoofer

Press SUBWOOFER ON/OFF on the subwoofer again.

Tip

To adjust the volume of all speakers at the same time, press VOLUME +/- repeatedly (or turn MASTER VOLUME on the unit).

Creating a party environment

— X-TRANCE/X-TRANCE PRO

You can create a party environment by using X-TRANCE (MHC-GN1000D only) or X-TRANCE PRO (FST-ZX100D/LBT-ZX100D/FST-ZX80D/LBT-ZX80D only).

The following table shows the sound effect available for X-TRANCE and X-TRANCE PRO.

Use the buttons on the unit for the operation.

Sound effect	X-TRANCE	X-TRANCE PRO
SOUND FLASH	•	
FLANGER	•	•
DELAY	•	•
CHORUS		•
X-ROUND		•
X-BEAT		•

Flashing sound effect

— SOUND FLASH

(MHC-GN1000D only)

With the sound flash function, you can flash the sound output. The sound cuts off periodically.

Hold down SOUND FLASH during playback.

The flashing effect is activated.

To cancel the flashing effect

Release SOUND FLASH.

To change the sound flash speed

Hold down SOUND FLASH and turn OPERATION DIAL clockwise or counterclockwise to change the sound flash speed (1 ~ 20).

Tip

- The power illuminator will synchronize with the selected SOUND FLASH effect.

Flanging sound effect

— FLANGER

You can flange the sound output with the sound flange function.

Press FLANGER repeatedly to select the FLANGER effect you want.

The FLANGER indicator lights up.

Select	To create
FLANGER 1 ¹⁾ or FLANGER ON ²⁾	a deep flanging effect that is similar to the roar of a jet plane.
FLANGER 2 ¹⁾	a standard flanging tone.

¹⁾FST-ZX100D/LBT-ZX100D/FST-ZX80D/LBT-ZX80D only.

²⁾MHC-GN1000 only.

To cancel the FLANGER effect

Press FLANGER repeatedly to select “FLANGER OFF”.

Notes

- You can only select the FLANGER effect in DVD function.
- The FLANGER effect is automatically set to “FLANGER OFF” when you:
 - turn off the system.
 - change the function.
 - select the DELAY or CHORUS effect.
- If you activate FLANGER during disc recording, the sound effect will be recorded onto the tape.

Delaying sound effect

— DELAY

You can delay the sound output with the sound delay function.

Press DELAY repeatedly to select the DELAY effect you want.

The DELAY indicator lights up.

Select	To create
DELAY 1 ¹⁾ or DELAY ON ²⁾	a “live” sound with full characteristic reverb effect.
DELAY 2 ¹⁾	a short delay to simulate the atmosphere of a live performance.

¹⁾FST-ZX100D/LBT-ZX100D/FST-ZX80D/
LBT-ZX80D only.

²⁾MHC-GN1000D only.

To cancel the DELAY effect

Press DELAY repeatedly to select “DELAY OFF”.

Notes

- You can only select the DELAY effect in DVD function.
- The DELAY effect is automatically set to “DELAY OFF” when you:
 - turn off the system.
 - change the function.
 - select the FLANGER or CHORUS effect.
- If you activate DELAY during disc recording, the sound effect will be recorded onto the tape.

Chorusing sound effect

— CHORUS

(FST-ZX100D/LBT-ZX100D/FST-ZX80D/
LBT-ZX80D only)

You can add chorus effect to the sound with the sound chorus function.

Press CHORUS repeatedly to select the CHORUS effect you want.

The CHORUS indicator lights up.

Select	To create
CHORUS 1	a slow and deep chorus effect.
CHORUS 2	a tremolo chorus with high speed setting.

To cancel the CHORUS effect

Press CHORUS repeatedly to select “CHORUS OFF”.

Notes

- You can only select the CHORUS effect in DVD function.
- The CHORUS effect is automatically set to “CHORUS OFF” when you:
 - turn off the system.
 - change the function.
 - select the FLANGER or DELAY effect.
- If you activate CHORUS during disc recording, the sound effect will be recorded onto the tape.

Moving sound effect

— X-ROUND

(FST-ZX100D/LBT-ZX100D/FST-ZX80D/
LBT-ZX80D only)

To enjoy the X-ROUND effect, place your front and surround speakers at an equal distance from your listening position (see “Positioning the speakers (Example 1)” on page 12).

Press one of the X-ROUND buttons repeatedly (WAVE, FADER, BALANCE, RANDOM) to select the X-ROUND mode you want.

“X-ROUND” lights up in the display.

Select	To output sound
AUTO WAVE ¹⁾ , MANUAL WAVE ²⁾	In circular motion around the room
AUTO FADER ¹⁾ , MANUAL FADER ²⁾	Back and forth between the front and surround speakers
AUTO BAL ¹⁾ , MANUAL BAL ²⁾	Back and forth between the left and right speakers
RANDOM	In random X-ROUND mode

- 1) You can change the speed of sound movement by turning the X-ROUND JOG clockwise or counterclockwise.
- 2) You can manually change the sound movement from one speaker to another speaker by turning the X-ROUND JOG clockwise or counterclockwise.

To cancel the X-ROUND effect

Press X-ROUND OFF. "X-ROUND OFF" appears in the display.

Notes

- If you cannot get the sound effect you want, check the speaker connections.
- When the headphones are connected to the PHONES jack, X-ROUND mode automatically turns off and you cannot change the setting.
- When the X-ROUND mode is turned on, the audio output from the center speaker and subwoofer is cut off.
- When you press SOUND FIELD or turn on the test tone, X-ROUND mode automatically turns off.
- You cannot turn on the X-ROUND mode when
 - the headphones are connected.
 - "SURROUND" in "SPEAKER SETUP" is set to "NONE".
 - test tone is performed.

Creating beat effect

— X-BEAT

(FST-ZX100D/LBT-ZX100D/FST-ZX80D/LBT-ZX80D only)

You can create the beat effect automatically or manually.

Creating the beat effect automatically

- 1 Press one of the X-ROUND buttons repeatedly (WAVE, FADER, BALANCE) to select the X-ROUND mode you want.

- 2 Press BEAT MAX repeatedly to select "TEMPO B.MAX" or press BEAT JUMP repeatedly to select "TEMPO B.JUMP" as follows:

Select	To
TEMPO B.MAX	Enhance the sound according to the tempo of the music.
TEMPO B.JUMP	Switch the sound position to the opposite direction instantly according to the tempo of the music.

- 3 Press BEAT PAD once. "1234" appears in the display.

- 4 Press BEAT PAD 4 times according to the tempo of the music. Each time you press BEAT PAD, the number in the display is replaced with an "X".

Creating the beat effect manually

- 1 Press one of the X-ROUND buttons repeatedly (WAVE, FADER, BALANCE) to select the X-ROUND mode you want.
- 2 Press BEAT MAX repeatedly to select "MANUAL B.MAX" or press BEAT JUMP repeatedly to select "MANUAL B.JUMP" as follows:

Select	To
MANUAL B.MAX	Enhance the sound at anytime you like (manually).
MANUAL B.JUMP	Switch the sound position to the opposite direction instantly at anytime you like (manually).

- 3 Press BEAT PAD.

Notes

- If you cannot get the sound effect you want, check the speaker connections.
- You can only select the X-BEAT mode if the X-ROUND mode is turned on and you select an X-ROUND mode other than "RANDOM".
- If you press other buttons on the unit, the X-BEAT mode may change.

Listening to the sound in another room

— Multi Room

(FST-ZX100D/LBT-ZX100D/ FST-ZX80D/LBT-ZX80D only)

You can place your front speakers in one room and your surround speakers in another room. Then, use the Multi Room function to select the speakers you want to turn on.

Press SPEAKERS on the unit.

Each time you press the button, the display changes cyclically as follows:

SPEAKERS A → SPEAKERS B →
SPEAKERS A+B

To select	Display
The front speakers	SPEAKERS A
The surround speakers	SPEAKERS B
Both the front and surround speakers	SPEAKERS A+B

Notes

- You cannot change the setting when
 - the headphones are connected.
 - “SURROUND” in “SPEAKER SETUP” is set to “NONE”.
 - test tone is performed.
- “SPEAKERS A” lights up in the display when SPEAKERS A is selected and “SPEAKERS B” lights up in the display when SPEAKERS B is selected.
- (FST-ZX100D/LBT-ZX100D only)
When you select “SPEAKERS B”, the subwoofer is turned off automatically.
- (FST-ZX80D/LBT-ZX80D only)
When you select “SPEAKERS B”, the audio output of the subwoofer is cut off.
- When you press SOUND FIELD or turn on the test tone, this function is automatically turned off.

Singing along: Karaoke



You can sing along with any multiplex AUDIO CD, multiplex VIDEO CD or DVD VIDEO in Dolby Digital Karaoke format. You need to connect an optional microphone.

Preparing for karaoke

(DVD VIDEO, DVD-R/DVD-RW in VR mode, VIDEO CD, AUDIO CD and MP3 audio tracks only)

- 1 Press FUNCTION +/- repeatedly to select “DVD” (or press DVD on the unit).**
- 2 Turn MIC 1 LEVEL or MIC 2 LEVEL on the unit to “MIN” to reduce the microphone volume and turn ECHO LEVEL on the unit to “MIN” to cancel the echo effect.**
- 3 Connect an optional microphone to MIC 1 or MIC 2 jack on the unit.**
Connect another optional microphone if you want to sing in duet.
The Karaoke Mode is turned on. “KARAOKE MODE: ON” appears on the TV screen and “” lights up in the display.
- 4 Start playing the music and adjust the volume.**

When Karaoke Mode is turned on during DVD VIDEO or DVD-R/DVD-RW in VR mode playback, the system outputs the audio format that you have selected. When Karaoke Mode is turned on during AUDIO CD, VIDEO CD or MP3 audio tracks playback, the audio setting automatically changes to “1/L” and the system outputs the left channel audio on both front and surround channels. If you want to hear vocal when Karaoke Mode is turned on, press AUDIO repeatedly to select another audio channel.

- 5** Start singing along with the music and adjust the microphone volume by turning MIC 1 LEVEL or MIC 2 LEVEL on the unit.

To adjust the microphone echo

Turn ECHO LEVEL on the unit to adjust the echo effect. To cancel the echo effect, turn ECHO LEVEL on the unit to "MIN".

To turn off the Karaoke Mode

Disconnect all the microphones or press KARAOKE MODE. "KARAOKE MODE: OFF" appears on the TV screen and "🎤" disappears from the display. You can also turn off the Karaoke Mode by pressing KARAOKE MODE even when the microphones are connected.

Notes

- If acoustic feedback (howling) occurs, move the microphone away from the speakers or change the direction of the microphone.
- Karaoke Mode is automatically turned off when you:
 - turn off the system.
 - change the function.
 - connect the headphones.
 - turn on the test tone.

Singing karaoke by reducing the vocal

(DVD VIDEO, DVD-R/DVD-RW in VR mode, VIDEO CD, AUDIO CD and MP3 audio tracks only)

You can enjoy karaoke with any disc, even if it is not a karaoke or multiplex disc by reducing the sound of the vocal.

- 1** Press  DISPLAY once or twice when Karaoke Mode is turned on while playing a disc.

The Control Menu appears on the TV screen.

- 2** Press  or  repeatedly to select  (KARAOKE PON), then press ENTER.

The options for "KARAOKE PON" appear on the TV screen.

- 3** Press  or  repeatedly to select "ON", then press ENTER.

The sound of vocal is reduced.

Notes

- The singer's voice may not be reduced when:
 - only a few instruments are playing.
 - a duet is being played back.
 - the source has strong echoes or chorus.
 - the singer's voice deviates from the center.
 - the voice on the source is singing in high soprano or tenor.
- To cancel the "KARAOKE PON" effect, select "OFF" in step 3.
- You can also change the "KARAOKE PON" setting by pressing KARAOKE PON when the Karaoke Mode is turned on. The following display appears on the TV screen.

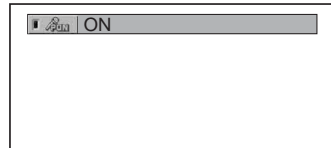

- The "KARAOKE PON" setting is automatically changed to "OFF" when you:
 - turn off the system.
 - change the function.
 - connect the headphones.
 - turn on the test tone.
 - turn off the Karaoke Mode.
 - open the disc tray.
 - change the disc.
 - set "VOCAL" to "ON".

Adjusting the pitch of the music

(DVD VIDEO, DVD-R/DVD-RW in VR mode, VIDEO CD, AUDIO CD and MP3 audio tracks only)

You can adjust the pitch of the music to suit your vocal range. You can adjust the key higher or lower in 13 steps (♭6 – #6).

- 1** Press  DISPLAY once or twice when Karaoke Mode is turned on while playing a disc.

The Control Menu appears on the TV screen.

continued

2 Press **↑** or **↓** repeatedly to select  (KEY CONTROL), then press ENTER.

3 Press **↑** or **↓** repeatedly to select the key you want.

The key is changed.

Notes

- You can also change the “KEY CONTROL” setting by pressing KEY CONTROL **▷** to reduce the key and KEY CONTROL **#** to increase the key when the Karaoke Mode is turned on. The following display appears on the TV screen.

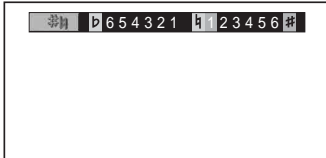

- The “KEY CONTROL” setting may automatically change to default setting when you:
 - turn off the system.
 - change the function.
 - connect the headphones.
 - turn on the test tone.
 - turn off the Karaoke Mode.
 - open the disc tray.
 - change the disc.
 - perform Lock Search or Slow-motion Play.
 - change the track or title.
- Depending on the disc, you may not be able to do the above operation.
- To cancel the “KEY CONTROL” effect, select “**◀**” in step 3.

Turning on the vocals



When Karaoke Mode is turned on and a DVD VIDEO in Dolby Digital Karaoke format is played back, you can turn on the guide vocal recorded in the tracks.

When Karaoke Mode is turned on and an AUDIO CD or VIDEO CD is played back, you can turn on the vocal either by selecting “STEREO” or “L+R”.

1 Press  DISPLAY once or twice when Karaoke Mode is turned on while playing a disc.

The Control Menu appears on the TV screen.

2 Press **↑** or **↓** repeatedly to select  (VOCAL), then press ENTER.

The options for “VOCAL” appear on the TV screen.

3 Press **↑** or **↓** repeatedly to select “ON”, then press ENTER.

The vocal is turned on.

■ During DVD VIDEO playback

You can listen to the guide vocal recorded in the Dolby Digital Karaoke format.

■ During AUDIO CD or VIDEO CD playback

When Karaoke Mode is turned on, the system outputs the left channel (accompaniment channel) from both front and surround speakers. You can listen to the vocal when you set “VOCAL” to “ON”.

Notes

- To turn off the vocal, select “OFF” in step 3.
- For DVD VIDEOS without guide vocal, you cannot turn on the vocal.
- When playing a DVD VIDEO, this function only works for Dolby Digital Karaoke format.
- The “VOCAL” setting is automatically changed to “OFF” when you:
 - turn off the system.
 - change the function.
 - connect the headphones.
 - turn on the test tone.
 - turn off the Karaoke Mode.
 - open the disc tray.
 - change the disc.
 - set “KARAOKE PON” to “ON”.

Dolby Digital Karaoke format

DVD-V

The Dolby Digital format, which reproduces surround sound using 5 channels, can also contain the “Dolby Digital Karaoke” format which is specialized for karaoke. In the Dolby Digital Karaoke format discs, guide melody and guide vocal tracks are recorded in addition to the accompaniment. You can select them when Karaoke Mode is turned on.

Speaker output in normal Dolby Digital format (5.1 channel)

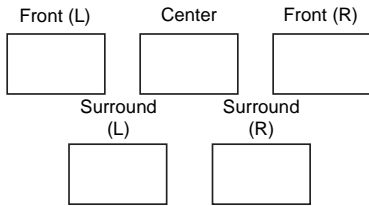

Speaker output in Dolby Digital Karaoke format

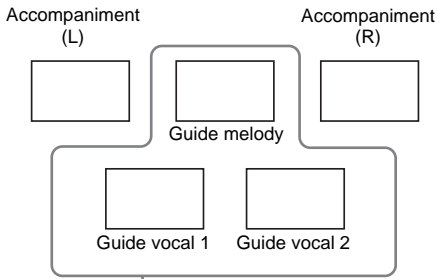

You can select any of these. These are output from the front and surround speakers.

You can check the audio information by pressing AUDIO (page 34). When playing a Dolby Digital Karaoke disc, “♪” appears at the current audio format (page 34).

Example:

DOLBY DIGITAL ♪ 3/2

- 2/0: Recorded only with accompaniment.
- 3/0: Recorded with guide melody.
- 3/1: Recorded with guide melody and one guide vocal.
- 3/2: Recorded with guide melody and two guide vocals.

Selecting the vocals

DVD-V

VIDEO CD

C D

After setting “VOCAL” to “ON”, you can change the vocal type.

- 1 Press DISPLAY once or twice when Karaoke Mode is turned on while playing a disc.

The Control Menu appears on the TV screen.

- 2 Press or repeatedly to select (VOCAL SELECT), then press ENTER.

The options for “VOCAL SELECT” appear on the TV screen.

- 3 Press or repeatedly to select the vocal type you want, then press ENTER.

The vocal is changed.

■ When playing a DVD VIDEO

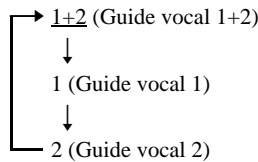

■ When playing a VIDEO CD or AUDIO CD

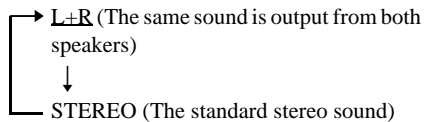

■ When playing a Super VCD

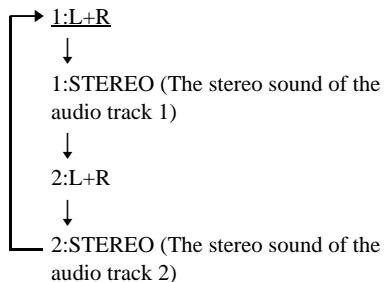

continued

Notes

- For DVD VIDEOS with 1 guide vocal recorded, you cannot change the vocal.
- When playing a DVD VIDEO, the function only works for Dolby Digital Karaoke format.
- The “VOCAL SELECT” setting is automatically changed to default setting when you
 - turn off the system.
 - change the function.
 - connect the headphones.
 - turn on the test tone.
 - turn off the Karaoke Mode.
 - open the disc tray.
 - change the disc.
- Depending on the disc, you may not be able to do the above operation.

Turning on the guide melody

DVD-V

You can turn on the guide melody when singing with DVD VIDEO in Dolby Digital Karaoke format.

- 1 Press  DISPLAY once or twice when Karaoke Mode is turned on while playing a disc.**

The Control Menu appears on the TV screen.

- 2 Press  or  repeatedly to select  (GUIDE MELODY), then press ENTER.**

The options for “GUIDE MELODY” appear on the TV screen.

- 3 Press  or  repeatedly to select “ON”, then press ENTER.**

The guide melody is turned on.

Notes

- To turn off the guide melody, select “OFF” in step 3.
- When playing a DVD VIDEO, the function only works for Dolby Digital Karaoke format.
- For DVD VIDEOS without guide melody, you cannot hear the guide melody even if you set the setting to “ON”.

- The “GUIDE MELODY” setting is automatically changed to “OFF” when you:
 - turn off the system.
 - change the function.
 - connect the headphones.
 - turn on the test tone.
 - turn off the Karaoke Mode.
 - open the disc tray.
 - change the disc.

Selecting the scoring mode





When Karaoke Mode is turned on, you can use the scoring mode.

Your score is calculated by comparing your voice with the music source.



- 1 Press  DISPLAY once or twice when Karaoke Mode is turned on while playing a disc.**

The Control Menu appears on the TV screen.

- 2 Press  or  repeatedly to select  (SCORE MODE), then press ENTER.**

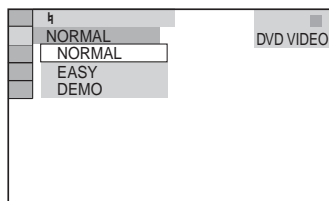
The options for “SCORE MODE” appear on the TV screen.



- 3 Press  or  repeatedly to select the setting you want.**

The default setting is underlined.

- NORMAL : Advance or professional level.
- EASY : Beginner or Intermediate level.
- DEMO : Demonstration mode.
Consistently displays a high score for every song.

- 4** Press **ENTER**.
- 5** Press **SCORE** before singing a song in **Karaoke Mode**.

The previous highest score appears on the TV screen.

- 6** After singing for more than a minute, press **SCORE** again to view your score.

Your score is calculated from a scale of 0 to 99.

Tip

The “SCORE MODE” setting is automatically changed to “NORMAL” when the system is turned off.

Notes

- The highest score is reset when the system is turned off.
- The score calculating function may be canceled when certain remote buttons are pressed.
- In some cases, you may not be able to use the scoring mode.

Mixing and recording sounds

You can “mix” sounds from any one of the function and singing or speaking into a microphone.

The mixed sound can be recorded onto a tape. Use the buttons on the unit for the operation.

- 1** Turn **MIC 1 LEVEL** or **MIC 2 LEVEL** to “**MIN**” to turn down the microphone volume.
- 2** Connect an optional microphone to **MIC 1** or **MIC 2** jack.
- 3** Prepare the music source you want to mix. Then, insert a recordable tape into **Deck B**.
- 4** Press the function button of the source you want to record (e.g., **DVD**).
If you want to record from **TAPE A**, press **TAPE A/B** repeatedly to select “**TAPE A**”.
- 5** Press **REC PAUSE/START**.
“**REC**” flashes in the display. **Deck B** stands by for recording.

- 6** Press **DIRECTION** repeatedly to select “**↔**” to record on one side. Select “**↔↔**” (or “**RELAY**”) to record on both sides.

- 7** Press **REC PAUSE/START**.
“**REC**” lights up in the display.
Recording starts.

- 8** Start playing the source to be recorded.
Start singing along with the music.

- 9** Adjust the microphone volume by turning **MIC 1 LEVEL** or **MIC 2 LEVEL**.

To stop recording

Press **■**.

After you have finished

Turn **MIC 1 LEVEL** or **MIC 2 LEVEL** to “**MIN**” and disconnect the microphone from **MIC 1** or **MIC 2** jack.

Note

During **DVD** function, the **Karaoke Mode** is automatically turned on when you connect an optional microphone to **MIC 1** or **MIC 2** jack.

Tips

- When recording from the reverse side:
After step 3, press **TAPE A/B** repeatedly to select “**TAPE B**”. Press **◀▶** repeatedly until the **TAPE B** reverse side indicator lights up to start playback of the reverse side. Press **■** at the point you want to start recording.
- When recording on both sides:
Be sure to start from the front side. If you start from the reverse side, recording stops at the end of the reverse side.
- If acoustic feedback (howling) occurs, move the microphone away from the speakers or change the direction of the microphone.
- If you want to record your voice through the microphone only, you can do so by selecting the **TAPE A** function and not playing any tape.
- When high level sound signals are input, the system automatically adjust the recording level to prevent distortion of the recorded sound signals (**Auto Level Control Function**).

Timer

Falling asleep to music

— Sleep Timer

You can set the system to turn off after a certain time, so that you can fall asleep to music.

Press SLEEP repeatedly.

Each time you press the button, the minute display (the turn-off time) changes cyclically as follows:

90min → 80min → 70min → ... → 10min → OFF

Other operations

To	Do this
Check the remaining time	Press SLEEP once.
Change the time to turn off	Press SLEEP repeatedly to select the time you want.
Cancel the Sleep Timer	Press SLEEP repeatedly until "SLEEP OFF" appears in the display.

Note

When the Sleep Timer is activated, "SLEEP" lights up in the display.

Tip

You can use the Sleep Timer even if you have not set the clock.

Waking up to music

— Play Timer

You can wake up to music at a preset time. Make sure you have set the clock (see "Setting the clock" on page 13).

1 Prepare the music source you want to playback.

- Disc: Load a disc.
- Tape: Load a tape with the side you want to play back facing forward.
- Radio: Tune in the preset station you want (see "Listening to the radio" on page 49).

2 Press **VOLUME +/-** (or turn **MASTER VOLUME** on the unit) to adjust the volume.

3 Press **TIMER MENU**.

4 Press **↑** or **↓** repeatedly to select "PLAY SET?", then press **ENTER**. "ON" appears and the hour indication flashes in the display.

5 Set the time to start playback.

Press **↑** or **↓** repeatedly to set the hour, then press **ENTER**.

The minute indication flashes in the display.

Press **↑** or **↓** repeatedly to set the minute, then press **ENTER**.

"OFF" appears and the hour indication flashes in the display.

6 Set the time to stop playback following the same procedure as step 5.

7 Press **↑** or **↓** repeatedly until the music source you want appears in the display.

Each time you press the button, the display changes as follows:

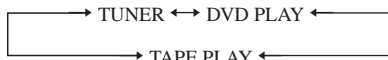

8 Press **ENTER**.

The type of timer ("PLAY TIMER"), followed by the start time, the stop time and the music source appears in the display in sequence before the original display returns.

9 Press **I/⏏** to turn off the system.

Other operations

To	Do this
Check the setting	<ol style="list-style-type: none"> 1 Press TIMER MENU. “TIMER SELECT?” flashes in the display. 2 Press ENTER. 3 Press ▲ or ▼ repeatedly to select “PLAY SELECT?”, then press ENTER.
Change the setting	Start from step 1.
Cancel the Play Timer	<ol style="list-style-type: none"> 1 Press TIMER MENU. “TIMER SELECT?” flashes in the display. 2 Press ENTER. 3 Press ▲ or ▼ repeatedly to select “TIMER OFF?”, then press ENTER.

Notes

- You cannot select the Play Timer and the Timer Recording at the same time.
- If you use the Play Timer and the Sleep Timer at the same time, the Sleep Timer has priority.
- The Play Timer will not be activated if the system is turned on or if “STANDBY” flashes in the display.

Tips

- The system turns on 30 seconds before the preset time.
- When Play Timer is selected, “PLAY” lights up in the display.

Timer recording radio programs

You can record from a preset radio station from a specified time.

To make timer recording, you must first preset the radio station (see “Presetting radio stations” on page 47) and set the clock (see “Setting the clock” on page 13).

- 1 Tune in the preset radio station (see “Listening to a preset radio station” on page 49).**
- 2 Press **TIMER MENU**.**
- 3 Press **▲** or **▼** repeatedly to select “REC SET?”, then press **ENTER**.**
“ON” appears and the hour indication flashes in the display.

4 Set the time to start recording.

Press **▲** or **▼** repeatedly to set the hour, then press **ENTER**.

The minute indication flashes in the display.

Press **▲** or **▼** repeatedly to set the minute, then press **ENTER**.

“OFF” appears and the hour indicator flashes in the display.

5 Set the time to stop recording following the same procedure as step 4.

The type of timer (“REC”), followed by the start time, the stop time and the preset radio station to be recorded (e.g., “TUNER FM 5”) appears in the display in sequence before the original display returns.

6 Load a recordable tape into Deck B.

Make sure the tape is in the front side.

7 Press **DIRECTION** on the unit repeatedly to select “**↔**” to record on one side or “**↔↔**” (or “**RELAY**”) to record on both sides.

When recording from the reverse side, press **FUNCTION +/-** (or **TAPE A/B** on the unit) repeatedly to select “**TAPE B**”. Then, press **▷** (or **◀▶** on the unit) repeatedly until the **TAPE B** reverse side indicator lights up to start playback of the reverse side. Press **■** at the point where you want to start recording.

When you record on both sides, be sure to start from the front side. If you start from the reverse side, recording stops at the end of reverse side.

8 Press **I/O** to turn off the system.

continued

Other operations

To	Do this
Check the setting	<ol style="list-style-type: none">1 Press TIMER MENU. “TIMER SELECT?” flashes in the display.2 Press ENTER.3 Press ▲ or ▼ repeatedly to select “REC SELECT?”, then press ENTER.
Change the setting	Start from step 1.
Cancel the Timer Recording	<ol style="list-style-type: none">1 Press TIMER MENU. “TIMER SELECT?” flashes in the display.2 Press ENTER.3 Press ▲ or ▼ repeatedly to select “TIMER OFF?”, then press ENTER.

Notes

- You cannot select the Play Timer and the Timer Recording at the same time.
- If you use the Timer Recording and the Sleep Timer at the same time, the Sleep Timer has priority.
- The Timer Recording will not be activated if the system is turned on or if “STANDBY” flashes in the display.
- The volume is reduced to minimum during Timer Recording.
- Do not operate the system from the time the system turns on until the recording starts (about 30 seconds before the preset time).

Tips

- The system turns on 30 seconds before the preset time.
- When Timer Recording is selected, “REC” lights up in the display.

Display

Turning off the display

— Power Saving Mode

The demonstration display and the clock display can be turned off to minimize the amount of power consumed during standby mode (Power Saving Mode).

Press DISPLAY repeatedly while the system is turned off until the demonstration display and the clock display disappears.

To cancel Power Saving Mode

Press DISPLAY repeatedly while the system is turned off. Each time you press the button, the display changes cyclically as follows: Demonstration¹⁾ → Clock²⁾ → No display (Power Saving Mode)

¹⁾ The display changes and the indicators flash even when the system is turned off.

²⁾ “- -: -” appears in the display if you have not set the clock.

Note

You cannot perform the following operations during Power Saving Mode:

- Setting the clock (page 13).
- Changing the AM tuning interval (page 48).
- Turning on the system by pressing DVD, TUNER/BAND, TAPE A/B, TV/SAT or VIDEO on the unit.

Tips

- The timer continues to operate in Power Saving Mode.
- The I/⏻ indicator lights up in red even in Power Saving Mode.

Changing the spectrum analyzer display

Use the buttons on the unit for the operation.

- 1 Press AMP MENU repeatedly to select "SPECTRUM".**

The last selected spectrum setting appears in the display.

- 2 Turn OPERATION DIAL clockwise or counterclockwise to select the setting you want.**

The display changes cyclically as follows:

SPECTRUM 1 ↔ SPECTRUM 2 ↔

SPECTRUM 3 ↔ SPECTRUM 4 ↔

SPECTRUM 5 ↔ SPECTRUM OFF

- 3 Press ENTER.**

**FST-ZX100D/LBT-ZX100D/FST-ZX80D/
LBT-ZX80D only**

When X-ROUND mode is selected

- 1 Press AMP MENU repeatedly to select "X-POSITION".**

The last selected spectrum setting appears in the display.

- 2 Turn OPERATION DIAL clockwise or counterclockwise to select the setting you want.**

The display changes as follows:

X-POS ON* ↔ X-POS OFF

*The spectrum analyzer display will synchronize with the selected X-ROUND effect.

- 3 Press ENTER.**

Adjusting the brightness of the front panel display

Use the buttons on the unit for the operation.

- 1 Press AMP MENU repeatedly to select "DIMMER".**

The last selected dimmer setting appears in the display.

- 2 Turn OPERATION DIAL clockwise or counterclockwise to select the setting you want.**

The display changes cyclically as follows:

DIMMER 1 ↔ DIMMER 2 ↔

DIMMER OFF

- 3 Press ENTER.**

Changing the power illuminator

Press ILLUMINATION on the unit repeatedly to select the power illuminator you want when the system is turned on.

Each time you press the button, the power illuminator changes cyclically as follows:

PATTERN 1 → PATTERN 2 →

PATTERN 3 → PATTERN 4 →

PATTERN OFF

**FST-ZX100D/LBT-ZX100D/
FST-ZX80D/LBT-ZX80D only**

When X-ROUND mode is selected

Press ILLUMINATION on the unit repeatedly to select the power illuminator you want.

Each time you press the button, the power illuminator changes as follows:

PATTERN OFF ↔ X-PATTERN*

* The power illuminator will synchronize with the selected X-ROUND effect.

Notes

- When you press VOLUME +/- (or turn MASTER VOLUME on the unit), the power illuminator shows the current volume level.
- During the demonstration display, you can turn on or off the power illuminator by pressing ILLUMINATION on the unit.

Viewing information about the disc in the front panel display

You can check the elapsed playing time and remaining time of the current track or that of the disc. When a DVD-TEXT disc, CD-TEXT disc, DATA CD or DATA DVD is loaded, you can also check the information recorded on disc, such as the titles.

Press DISPLAY repeatedly.

Each time you press the button, the display changes cyclically as follows:
Disc information → Clock display¹⁾ (for 8 seconds) → Effect name (for 8 seconds)

Checking the elapsed playing time, remaining time and titles

Press TIME/TEXT repeatedly during playback.

Each time you press the button, the display changes cyclically as follows:

- **When playing a DVD VIDEO or DVD-R/ DVD-RW in VR mode**
 - When the menu or the title without a chapter is played back
Elapsed playing time of the menu or the current title → Title of the disc²⁾
 - When a chapter other than above condition is played back
Elapsed playing time of the current title →
Remaining time of the current title →
Elapsed playing time of the current chapter →
Remaining time of the current chapter →
Title of the disc²⁾³⁾

- **When playing an AUDIO CD or VIDEO CD without PBC function**

Elapsed playing time of the current track →
Remaining time of the current track → Elapsed playing time of the current disc⁴⁾ → Remaining time of the current disc⁴⁾ → Title of the disc²⁾⁶⁾

- **When playing a VIDEO CD/Super VCD with PBC function**

Elapsed playing time of the current scene →
Title of the disc²⁾⁷⁾

- **When playing a Super VCD without PBC function**

Elapsed playing time of the current track → Title of the disc²⁾⁶⁾

- **When playing MP3 audio tracks on a DATA CD or DATA DVD**

Elapsed playing time of the current track →
Title of the track

Checking the total playing time and titles

Press TIME/TEXT repeatedly when playback is stopped.

Each time you press the button, the display changes cyclically as follows:

- **DVD VIDEO or DVD-R/DVD-RW in VR mode**

Total number of titles on the disc →
Title of the disc²⁾

- **VIDEO CD without PBC playback or AUDIO CD**

Total number of the tracks on the disc and the total playing time of the disc →
Title of the disc²⁾

■ VIDEO CD with PBC playback

Total number of scene on the disc →
Title of the disc²⁾

- 1) “_ _: _: _” appears in the display if you have not set the clock.
- 2) “NO TEXT” appears in the display if the DVD VIDEO is not a DVD-TEXT disc, the AUDIO CD is not a CD-TEXT disc or the VIDEO CD does not have text information.
- 3) The current chapter number and the current title number is displayed for 2 seconds before the display returns to elapsed playing time when you press TIME/TEXT during display of title of the disc.
- 4) When Program Play or Shuffle Play is turned on, the elapsed playing time and the remaining time of the disc would be skipped.
- 5) The current album number and the current file number is displayed for 2 seconds before the display returns to elapsed playing time when you press TIME/TEXT during display of title of the file.
- 6) The current track number and current index number is displayed for 2 seconds before the display returns to elapsed playing time when you press TIME/TEXT during display of the title of disc.
- 7) The current scene number is displayed for 2 seconds before the display returns to elapsed playing time when you press TIME/TEXT during display of title of the disc.

Notes

- If you play back a disc containing JPEG image files only, “JPEG” or “No Audio” appears in the display.
- When the selected disc is a DATA CD or DATA DVD with MP3 audio tracks and/or JPEG image files, the total number of albums on the disc appears in the display when playback is stopped and the list of album/title/file is not displayed on the TV screen.
- You cannot use TIME/TEXT to change the display of disc information when:
 - a JPEG image file is played back.
 - playback is stopped for DATA CD or DATA DVD with MP3 audio tracks and/or JPEG image files.
- If the MP3 audio track title contains characters which cannot be displayed, these characters will be displayed as “**”.
- The elapsed playing time of MP3 audio tracks may not be displayed correctly.

Viewing information about the disc in the on-screen display

You can check the elapsed playing time and remaining time of the current title, chapter, or track, and the total playing time of the disc. You can also check the disc title, track title and file title recorded on the disc.

Press TIME/TEXT repeatedly during playback to change the time information.

The time display that you can view on the TV screen depends on the disc you are playing.

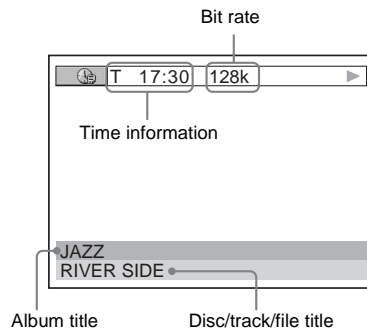

Display

■ When playing a DVD VIDEO or DVD-R/ DVD-RW in VR mode

- T **: **: **
Elapsed playing time of the current title
- T_ **: **: **
Remaining time of the current title
- C **: **: **
Elapsed playing time of the current chapter
- C_ **: **: **
Remaining time of the current chapter
- **: **: **: **
Elapsed playing time of the menu or current title without a chapter

■ When playing a VIDEO CD/Super VCD with PBC function

- **: **: **
Elapsed playing time of the current scene

continued

■ **When playing a Super VCD without PBC function**

- T **:.* Elapsed playing time of the current track

■ **When playing an AUDIO CD or VIDEO CD without PBC function**

- T **:.* Elapsed playing time of the current track
- T _*:.* Remaining time of the current track
- D **:.* Elapsed playing time of the current disc
- D _*:.* Remaining time of the current disc

■ **When playing MP3 audio tracks on a DATA CD or DATA DVD**

- T **:.* Elapsed playing time of the current track

Notes

- Only alphabet letters, numbers and some symbols can be displayed.
- Depending on the type of disc being played back, the system can only display a limited number of characters. Depending on the disc, not all text characters are displayed.
- For MP3 audio tracks with format other than ISO 9660 Level 1 and Level 2, album title and track title may not be displayed.

Checking the date information of JPEG image files

(JPEG image file only)

You can check the date information during playback when Exif* tag is recorded in the JPEG image files.

Press  **DISPLAY** repeatedly during playback until the Control Menu for JPEG image files appears on the TV screen.

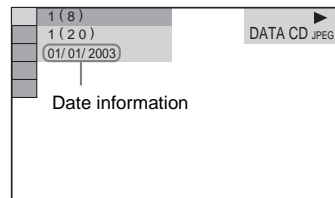

* “Exchangeable Image File Format” is a digital camera image format defined by the Japan Electronics & Information Technology Industries Association (JEITA).

Notes

- If there is no date information or the data is damaged on the disc, the system cannot display the date information.
- The date information format varies depending on the area.

Optional Components

Hooking up optional components

To enhance your system, you can connect optional components. Refer to the operating instructions provided with each component.

Front panel

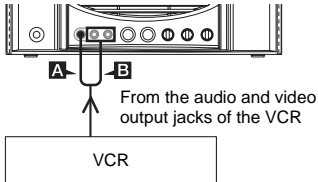

Rear panel of FST-ZX100D/LBT-ZX100D/ MHC-GN1000D only

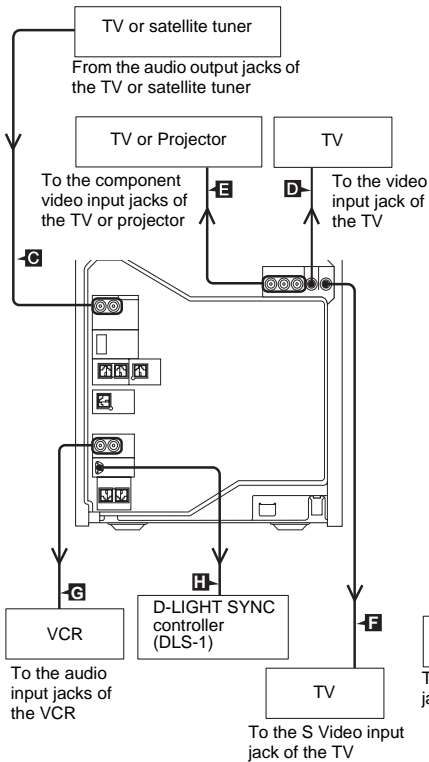

Rear panel of FST-ZX80D/LBT-ZX80D only

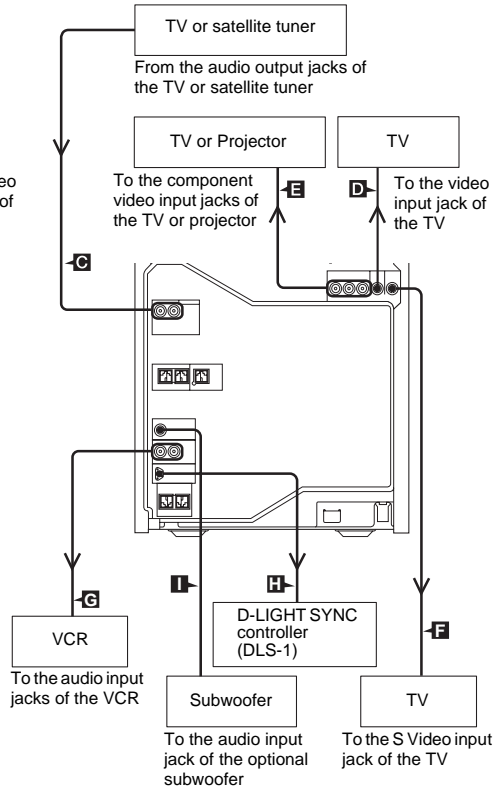

A VIDEO INPUT VIDEO jack

Use a video cord (not supplied) to connect the video output jack of the VCR to this jack. You can then output video signal through this system.

B VIDEO INPUT AUDIO L/R jacks

Use audio cords (not supplied) to connect the audio output jacks of the VCR to these jacks. You can then output audio signal through this system.

C TV/SAT AUDIO IN L/R jacks

Use audio cords (not supplied) to connect the audio output jacks of an optional component (such as TV or satellite tuner) to these jacks. You can then output audio signal through this system.

D VIDEO OUT jack

Use a video cord (supplied) to connect the video input jack of the TV to this jack.

E COMPONENT VIDEO OUT jacks

Use component video cords (not supplied) to connect the component video input jacks of the TV or projector to these jacks. If your TV accept progressive format signals, you must use this connection and press PROGRESSIVE on the unit repeatedly to select "P AUTO" or "P VIDEO". You can enjoy higher quality video images.

Note

You cannot output the video signal from the VIDEO INPUT VIDEO jack through the COMPONENT VIDEO OUT jacks of this unit.

F S VIDEO OUT jack

Use an S video cord (not supplied) to connect the S video input jack of the TV to this jack. You can enjoy higher quality video images.

Note

You cannot output the video signal from the VIDEO INPUT VIDEO jack through the S VIDEO OUT jack of this unit.

G AUDIO OUT jacks

Use audio cords (not supplied) to connect the audio input jacks of an optional component (such as VCR) to these jacks. You can then output audio signal to that component from this system.

Note

There is no audio output from these jacks when you select the VIDEO, SAT or TV function.

H D-LIGHT SYNC OUT jack

Connect the D-LIGHT SYNC controller to this jack. You need to connect the D-LIGHT SYNC controller to a lighting device* (not supplied). The lighting device will react according to the control signals transmitted by the D-LIGHT SYNC controller upon receiving music source from the system. For details on the use of the D-LIGHT SYNC controller and lighting device, refer to the operating instructions supplied with the respective device.

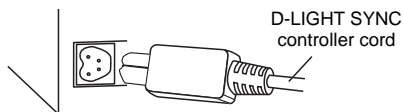

* Refer to the operating instructions supplied with the D-LIGHT SYNC controller for the recommended lighting device.

Note

The lighting effect may be different depending on the connected lighting device or the type of music being played back.

I SUBWOOFER OUT jack (FST-ZX80D and LBT-ZX80D only)

Use an audio cord (not supplied) to connect the audio input jack of an optional subwoofer* to this jack.

* SA-GNV111D is recommended.

In some areas, the SA-GNV111D may not yet be available.

Note

The effect may be limited or noise may occur depending on the connected subwoofer or the type of music being played back. For details, consult your nearest Sony dealer.

Listening to audio from a connected component

Listening to a connected TV or satellite tuner

Use the buttons on the unit for the operation.

1 Connect the audio cords.

See “Hooking up optional components” on page 71.

2 Press TV/SAT.

To switch between the “TV” and “SAT” function

Hold down TV/SAT and press I/⏻ while the system is turned on. Release I/⏻ first, then release TV/SAT. The system switches the function from “TV” to “SAT” or vice versa.

Note

If the sound is distorted or too loud when “TV” is selected, change the function to “SAT”.

Listening to a connected VCR

1 Connect the audio and video cords.

See “Hooking up optional components” on page 71.

2 Press VIDEO on the unit.

Start playing the connected VCR.

Note

The video signal from the connected VCR is only output through the VIDEO OUT jack of this unit.

Tip

You can press FUNCTION +/- repeatedly to select “TV”, “SAT” or “VIDEO”.

Recording audio signal from a connected component

1 Connect the audio cords.

See “Hooking up optional components” on page 71.

2 Start recording manually.

See “Recording onto a tape manually” on page 51.

Recording audio signal on a connected component

Recording the audio signal on a connected component

1 Connect the audio cords.

See “Hooking up optional components” on page 71.

2 Start recording.

Refer to the operating instructions provided with connected component.

Recording the audio and video signals from a VIDEO CD onto a video tape

1 Connect optional audio cords from the AUDIO OUT jacks and the supplied video cord from the VIDEO OUT jack to the audio and video input jacks of your VCR.

2 Start recording.

Refer to the operating instructions provided with connected component.

Note

The audio signal from the AUDIO OUT jacks may cut off for a moment during some operations such as when you press SOUND FIELD, AUDIO or KARAOKE MODE.

Troubleshooting

Problems and remedies

Should you encounter a problem with your system, do the following:

- 1 Make sure the power cord and speaker cords are connected correctly and firmly.
- 2 Find your problem in the troubleshooting checklist below and take the indicated corrective action.

If the problem persists after doing all of the above, consult your nearest Sony dealer.

When the I/⏻ indicator flashes

Immediately unplug the power cord and check the following items.

- (FST-ZX100D/LBT-ZX100D/MHC-GN1000D only)
Is the system control cable connected correctly?
- If your unit has a voltage selector, is the voltage selector set to the correct voltage? Check the voltage for your region, then make sure the voltage selector is set correctly.
- Are the + and – speaker cords short-circuited?
- Are you using the supplied speakers?
- Is anything blocking the ventilation holes on the rear of the unit?

After checking the above items and fixing any problems, plug in the power cord again and turn on the unit. If the I/⏻ indicator still flashes, or if the cause of the problem cannot be found even after checking all the above items, consult your nearest Sony dealer.

General

The display starts flashing as soon as you plug in the power cord even though you have not turned on the system.

- The demonstration mode started. Press I/⏻ (see step 7 of “Hooking up the system” on page 11).

The clock or timer setting is canceled.

- The power cord is disconnected or a power failure occurred. Redo “Setting the clock” (page 13). If you have set the timer, redo “Waking up to music” (page 64) and “Timer recording radio programs” (page 65).

The radio presetting is canceled.

- The power cord is disconnected or a power failure occurred for longer than half a day. Redo “Presetting radio stations” (page 47).

“- -: -” appears in the display.

- A power failure has occurred. Set the clock (page 13) and timer settings (page 64 and 65) again.

There is no sound.

- Press VOLUME + repeatedly (or turn MASTER VOLUME on the unit clockwise).
- The headphones are connected to the PHONES jack.
- Check the speaker connections (page 9).
- There is no audio output during Timer Recording.
- The system is in pause mode, in Slow-motion Play or in Lock Search. Press ▷ (or ◀▶ on the unit) to start the playback.

There is no microphone sound.

- Press VOLUME + repeatedly (or turn MASTER VOLUME on the unit clockwise) or turn MIC 1 LEVEL or MIC 2 LEVEL on the unit clockwise to adjust the microphone volume.
- Make sure the microphone is connected to the MIC 1 or MIC 2 jack correctly.

There is severe hum or noise.

- A TV or VCR is placed too close to the unit. Move the unit away from the TV or VCR.
- Move the unit away from the source of noise.
- Connect the unit to a different wall outlet.
- Install a noise filter (commercially available) to the power cord.

The timer does not function.

- Check the timer setting and set the correct time (page 64 and 65).
- Cancel the Sleep Timer function (page 64).
- You cannot select the Play Timer and the Timer Recording at the same time.

The remote does not function.

- Remove the obstacles between the remote and the unit.
- Move the remote closer to the unit.
- Point the remote at the unit's sensor.
- Replace the batteries (R6/size AA).
- Locate the unit away from the fluorescent light.

There is acoustic feedback.

- Reduce the volume.
- Move the microphone away from the speakers or change the direction of the microphone.

The color irregularity on a TV screen persists.

- Turn off the TV set once, then turn it on after 15 to 30 minutes. If the color irregularity still persists, place the speakers farther away from the TV set.

The sound from the component connected to the TV/SAT AUDIO IN L/R jacks is distorted.

- If "TV" appears in the display when you press TV/SAT on the unit, switch to "SAT" function (see "Listening to a connected TV or satellite tuner" on page 73).

The sound from the music source has echo effects.

- Press FLANGER and DELAY repeatedly until the FLANGER and DELAY indicators light off.
- (FST-ZX100D/LBT-ZX100D/FST-ZX80D/LBT-ZX80D only)
Press CHORUS repeatedly until the CHORUS indicator lights off.

Speakers

Sound comes from one channel or unbalanced left and right volume.

- Place the speakers as symmetrically as possible.
- Check that the speaker are connected securely and correctly.
- The source being played back is monaural.
- (FST-ZX100D/LBT-ZX100D/FST-ZX80D/LBT-ZX80D only)
Turn off the X-ROUND mode (page 57).
- Adjust the level of each speaker (page 46).

The sound comes from the center speaker only.

- Depending on the disc, the sound may come from the center speaker only.

There is no sound from the subwoofer.

- Set the subwoofer level to the appropriate level.
- No sound is produced from the subwoofer when you play back a DVD VIDEO that does not have subwoofer output recorded.
- The software being played back has limited sound effects.
- Check that the subwoofer is connected securely and correctly.
- Make sure that "SUBWOOFER" is set to "YES" (page 45).

There is no sound from the center/surround speaker.

- Set the center/surround speaker level to the appropriate level.
- The software being played back has limited sound effects. Check the volume with the test tone (page 46).
- Check that the center/surround speakers are connected securely and correctly.
- Make sure that "SURROUND" is set to "SIDE" or "BEHIND" (page 45).
- Make sure that "CENTER" is set to "YES" (page 45).

Sound lacks bass.

- Check that the speaker's + and - terminals are connected correctly.

Disc Player

The disc tray does not open and "LOCKED" appears in the display.

- Consult your nearest Sony dealer or local authorized Sony service facility.

The disc tray does not close.

- Load the disc correctly.
- Always close the disc tray by pressing **▲ OPEN/CLOSE** on the unit. Do not forcibly push the disc tray to close it as this may cause a malfunction.

The disc does not eject.

- You cannot eject the disc during CD Synchro Recording. Press **■** to cancel the CD Synchro Recording, then press **▲ OPEN/CLOSE** on the unit to eject the disc.
- Consult your nearest Sony dealer.

Playback does not start.

- Open the disc tray and check whether a disc is loaded.
- Wipe the disc clean (page 81).
- Reload the disc.
- Load the disc that this system can play back (page 6).
- Load the disc correctly.
- Load the disc on the disc tray with the label side facing up.
- Remove the disc and wipe away the moisture on the disc, then leave the system turned on for a few hours until the moisture evaporates.
- Press ▷ (or ◀▶ on the unit) to start playback.
- The region code on the DVD VIDEO does not match the system.
- Cancel the Custom Parental Control function (page 36).

The sound skips.

- Wipe the disc clean (page 81).
- Reload the disc.
- Move the unit to a place without vibration (e.g., on top of a stable stand).
- Move the speakers away from the unit, or place them on separate stands. When you listen to a track with bass sounds at high volume, the speaker vibration may cause the sound to skip.

Playback does not start from the first track.

- The system is in Program Play or Shuffle Play mode. Turn off Program Play and Shuffle Play.
- Resume Play has been selected. Press ■ twice. Then, press ▷ (or ◀▶ on the unit) to start playback (page 19).
- The DVD VIDEO's titles or PBC menu automatically appears on the TV screen.

Playback starts automatically.

- The DVD VIDEO features an auto playback function.

Playback stops automatically.

- Some discs may contain an auto pause signal. While playing such a disc, the playback stops at auto pause signal.

You cannot perform some functions such as Stop, Lock Search, Slow-motion Play, Repeat Play, Shuffle Play or Program Play.

- Depending on the disc, you may not be able to do some of the operations above. Refer to the operating instructions supplied with the disc.

The MP3 audio track cannot be played back.

- The DATA CD is not recorded in an MP3 format that conforms to ISO 9660 Level 1, Level 2, or Joliet in expansion format.
- The DATA DVD is not recorded in an MP3 format that conforms to UDF (Universal Disk Format).
- The MP3 audio track does not have the extension “.MP3”.
- The data is not stored in MP3 format.
- The MP3 audio tracks in format other than MPEG 1 Audio Layer 3 cannot be played back.
- The system can playback to a depth of 8 folders only.
- The “MODE (MP3, JPEG)” setting has been set to “IMAGE (JPEG)” (page 29).
- The disc contains more than 200 albums.
- The album contains more than 600 tracks when the “MODE (MP3, JPEG)” is set to “AUDIO (MP3)”.
- The album contains more than 300 tracks when the “MODE (MP3, JPEG)” is set to “AUTO”.

The MP3 audio tracks take longer time to play back than others.

- After the system reads all the tracks on the disc, playback may take more time than usual if:
 - the number of albums or tracks on the disc is very large.
 - the album and track organization structure is very complex.

The JPEG image file cannot be played back.

- The DATA CD is not recorded in a JPEG format that conforms to ISO 9660 Level 1, Level 2, or Joliet in expansion format.
- The DATA DVD is not recorded in a JPEG format that conforms to UDF (Universal Disk Format).
- The JPEG image file does not have the extension “.JPG” or “.JPEG”.
- The data is not stored in JPEG format.
- The JPEG image file is larger than 3,072 (width) × 2,048 (height) in normal mode, or more than 2,000,000 pixels in Progressive JPEG mode which is mainly used on the Internet website.
- The “MODE (MP3, JPEG)” setting has been set to “AUDIO (MP3)” (page 29).
- The system can play back to a depth of 8 folders only.
- JPEG image files with a high width to length ratio cannot be played back.
- The disc contains more than 200 albums.
- The album contains more than 600 files when the “MODE (MP3, JPEG)” is set to “IMAGE (JPEG)”.
- The album contains more than 300 files when the “MODE (MP3, JPEG)” is set to “AUTO”.

The disc title, album title, track title, CD-TEXT and DVD-TEXT characters do not appear properly.

- Use a disc that conforms to the ISO 9660 Level 1, Level 2, or Joliet in expansion format.
- The character code that can be displayed by this system are as follows:
 - Upper cases (A to Z)
 - Lower cases (a to z)
 - Numbers (0 to 9)
 - Symbols (<> * +, - / [] \ _)
- Other characters may not be displayed correctly.

The surround effect is difficult to hear when you are playing a Dolby Digital or MPEG audio sound track.

- Make sure the sound field is set properly (page 53).
- Check the speaker connections and settings (pages 9 and 44).
- Depending on the DVD VIDEO, the output signal may not be the entire 5.1 channel. It may be monaural or stereo, even if the sound track is recorded in Dolby Digital or MPEG audio format.

The sound loses stereo effect when you play back an AUDIO CD, VIDEO CD, MP3 audio track or DVD VIDEO .

- Unplug the microphone or press KARAOKE MODE repeatedly until “” disappears from the display.
- Make sure the system is connected properly.

Picture

There is no picture.

- Press FUNCTION +/- repeatedly to select “DVD” (or press DVD on the unit).
- Check that the system is connected securely.
- The video cord is damaged. Replace it with a new one.
- Make sure you connect the unit to the video input jack of your TV (page 10).
- Make sure you turn on the TV and operate the TV correctly.
- Press PROGRESSIVE on the unit repeatedly to select “INTERLACE” if you connect your TV to the unit’s COMPONENT VIDEO OUT jacks and your TV cannot accept progressive signal.
- You have set to progressive format but your TV cannot accept the signal in progressive format. In this case, set to interlace format (the default setting) (page 16).
- Even if your TV is compatible with progressive format signals, the image may be affected when you set to progressive format. In this case, set to interlace format (the default setting) (page 16).
- Make sure you select the video input on the TV so that you can view the pictures from the system.

Picture noise appears.

- Clean the disc.
- If video signal from your system has to go through your VCR to your TV, the copy-protection applied to some DVD VIDEO programs could affect the picture quality. If you still experience problems after checking your connections, connect your unit directly to your TV’s S Video input (page 10).

The aspect ratio of the TV screen cannot be changed even though you can set “TV TYPE” under “SCREEN SETUP” in the Setup Menu when you play back a wide picture.

- The aspect ratio is fixed on your DVD VIDEO.
- If you connect the unit with the S Video cord, connect directly to the TV. Otherwise, you may not change the aspect ratio.
- Depending on the TV, you may not change the aspect ratio.

Messages do not appear on the TV screen in the language you want.

- Select the language you want for the on-screen display in “OSD” under “LANGUAGE SETUP” in the Setup Menu (page 41).

The language for the sound track cannot be changed.

- Multilingual tracks are not recorded on the DVD VIDEO being played back.
- The DVD VIDEO prohibits changing the language for the sound track.

The subtitles language cannot be changed.

- Multilingual subtitles are not recorded on the DVD VIDEO being played back.
- The DVD VIDEO prohibits changing the subtitles.

The subtitles cannot be turned off.

- The DVD VIDEO prohibits turning off subtitles.

The angles cannot be changed.

- Multi-angles are not recorded on the DVD VIDEO being played back.
- The DVD VIDEO prohibits changing the angles.

Tuner

There is severe hum or noise. (“TUNED” or “STEREO” flashes in the display)

- Set the proper band and frequency (page 47).
- Connect the antenna properly (page 10).
- Find a place and an orientation that provide good reception, then set up the antenna again. If you cannot obtain good reception, we recommend that you connect a commercially available external antenna.
- The supplied FM lead antenna receives signals along its entire length, so make sure you extend it fully.
- Locate the antennas as far away from the speaker cords as possible.
- Try turning off the surrounding electrical equipment.

A stereo FM program cannot be received in stereo.

- Press FM MODE repeatedly until “MONO” disappears from the display.

Tape deck

The tape does not record or playback, or there is a decrease in sound level.

- The tape heads are dirty (see “Cleaning the tape heads” on page 82).
- The record/playback heads are magnetized (see “Demagnetizing the tape heads” on page 82).

The tape does not erase completely.

- The record/playback heads are magnetized (see “Demagnetizing the tape heads” on page 82).

There is excessive wow or flutter, or the sound drops out.

- The capstans or pinch rollers are dirty (see “Cleaning the tape heads” on page 82).

Noise increases or the high frequencies are erased.

- The record/playback heads are magnetized (see “Demagnetizing the tape heads” on page 82).

The tape does not record.

- No tape is loaded. Load a tape.
- The tab has been removed from the tape. Cover the broken tab with adhesive tape (page 82).
- The tape has reeled to the end.

When you press ◀◀ or ▶▶, “Not in Use” flashes in the display.

- The system does not have AMS (Automatic Music Sensor) function. This is not a malfunction.

The recorded sound has echo effect.

- Before you start recording, press FLANGER and DELAY repeatedly until the FLANGER and DELAY indicators light off.
- (FST-ZX100D/LBT-ZX100D/FST-ZX80D/LBT-ZX80D only)
Before you start recording, press CHORUS repeatedly until the CHORUS indicator lights off.

Optional components

There is no sound.

- Refer to General item “There is no sound.” (page 74) and check the condition of the system.
- Connect the component properly (page 71) while checking:
 - if the cords are connected properly.
 - if the cord plugs are firmly inserted all the way.
- Turn on the connected component.
- Refer to the operating instructions supplied with the connected component and start playing.







If the system still does not operate properly after performing the above measures or other troubles not described above occur, reset the system as follows:

Use the buttons on the unit for the operation.

- 1 Unplug the power cord.
- 2 Plug the power cord back in.
- 3 Press I/⏻ to turn on the system.
- 4 Press ■, ENTER and I/⏻ at the same time. “COLD RESET” appears in the display.

The system is reset to the factory settings except for DVD settings. You should set the settings you made, such as the preset stations, clock and timer.

To return the DVD setup to the default settings*, perform reset as follows:

- 1 Press  DISPLAY when playback is stopped.
The Control Menu appears on the TV screen.
- 2 Press  or  repeatedly to select  (SETUP), then press ENTER.
- 3 Press  or  repeatedly to select “RESET”, then press ENTER.

4 Press or repeatedly to select “YES”, then press ENTER

It takes a few seconds to complete. Do not press I/⏻ when resetting the system.

* Except for Parental Control settings

Notes

- (FST-ZX100D/LBT-ZX100D/MHC-GN1000D only)
Turn off the subwoofer before you reset the system.
- (FST-ZX80D/LBT-ZX80D only)
If you have connected an optional subwoofer, turn off the subwoofer before you reset the system.

Self-diagnosis Function

(When letters/numbers appear in the display)

When the self-diagnosis function is activated to prevent the system from malfunctioning, a 5-character service number (e.g. C 13 50) with a combination of a letter and 4 digits appears on the TV screen and the front panel display. In this case, check the following table.

First 3 characters of the service number	Cause and corrective action
C 13	This disc is dirty. <ul style="list-style-type: none">• Clean the disc with a soft cloth (page 81).
C 31	The disc is not inserted correctly. <ul style="list-style-type: none">• Restart the system, then re-insert the disc correctly.
E XX (XX is a number)	To prevent a malfunction, the system has performed the self-diagnosis function. <ul style="list-style-type: none">• Contact your nearest Sony dealer or local authorized Sony service facility and give the 5-character service number. Example: E 61 10

When displaying the version number on the TV screen

When you turn on the system, the version number [VER.X.XX] (X is a number) may appear on the TV screen. Although this is not a malfunction and for Sony service use only, normal system operation will not be possible. Turn off the system, and then turn on the system again to operate.



Messages

One of the following messages may appear or flash in the front panel display during operation.

Disc

Cannot Play

- A disc that cannot be played back was inserted.
- A DVD VIDEO with unsupported region code was inserted.

No Disc

There is no disc on the disc tray.

Push STOP!

You have pressed the buttons whose operation is only possible when playback is stopped.

Reading

The system is reading information of the disc. Some buttons are not available.

Please Wait

The system is doing initialization process.

Data Error

- The MP3 audio track and JPEG image file you want to play back is damaged.
- The MP3 audio track does not conform to MPEG 1 Audio Layer 3 format.
- The JPEG image file does not conform to DCF format.
- The MP3 audio track has the extension “.MP3” but it is not in MP3 format.
- The JPEG image file has the extension “.JPG” or “.JPEG” but it is not in JPEG format.

PASSWORD

Custom Parental Control or Parental Control is set.

Tape

No Tab

You cannot record the tape because the tab has been removed from the tape.

No Tape

There is no tape in the tape deck.

Timer

OFF TIME NG!

The on time and off time of Play Timer or Timer Recording is the same.

Others

Not in Use

You have pressed a button whose operation is not allowed or invalid at that time.

Invalid

You have pressed an invalid button.

Additional Information

Precautions

On operating voltage

Before operating the system, check that the operating voltage of the unit is identical with the voltage of your local power supply.

On safety

- The unit is not disconnected from the AC power source (mains) as long as it is connected to the wall outlet, even if the unit itself has been turned off.
- Unplug the unit from the wall outlet (mains) if it is not to be used for an extended period of time. To disconnect the power cord (mains lead), pull it out by the plug. Never pull the cord itself.
- Should any solid object or liquid fall into the unit, unplug the unit and have it checked by qualified personnel before operating it any further.
- One blade of the plug is wider than other for the purpose of safety and will fit to the wall outlet only one way. If you are unable to insert the plug fully into the outlet, contact your dealer.
- AC power cord must be changed only at the qualified service shop.

On placement

- Do not place the unit in an inclined position.
- Do not place the unit in locations where it is:
 - extremely hot or cold
 - dusty or dirty
 - very humid
 - subject to vibrations
 - subject to direct sunlight.
- Use caution when placing the unit or speakers on surfaces that have been specially treated (with wax, oil, polish, etc.) as staining or discoloration of the surface may result.

On heat build-up

- Although the unit heats up during operation, this is not a malfunction.
- Place the unit in a location with adequate ventilation to prevent heat build-up in the unit.
- If you continuously use this unit at a large volume, the cabinet temperature of the top, side and bottom rises considerably. To avoid burning yourself, do not touch the cabinet.
- To prevent a malfunction, do not cover the ventilation hole for the cooling fan.

In case color irregularity is observed on a nearby TV screen

With the magnetically shielded type of speakers, the speakers can be installed near a TV set. However, color irregularity may still be observed on the TV screen depending on the type of your TV set.

If color irregularity is observed...

Turn off the TV set once, then turn it on after 15 to 30 minutes.

If color irregularity is observed again...

Place the speakers farther away from the TV set.

IMPORTANT NOTICE

Caution: This system is capable of holding a still video image or on-screen display image on your TV screen indefinitely. If you leave the still video image or on-screen display image displayed on your TV for an extended period of time, you risk permanent damage to your TV screen. Projection TVs are especially susceptible to this.

On operation

- If the unit is brought directly from a cold to a warm location, or is placed in a very damp room, moisture may condense on the lens inside the unit. Should this occur, the system will not operate properly. Remove the disc and leave the system turned on for about an hour until the moisture evaporates.
- Before you move the unit, make sure that all discs are removed from the unit.

If you have any questions or problems concerning your system, please consult your nearest Sony dealer.

On cleaning disc, disc/lens cleaner

Do not use a commercially available cleaning disc or disc/lens cleaner (wet or spray type). These may cause apparatus to malfunction.

Notes on discs

- Before playing, clean the disc with a cleaning cloth. Wipe the disc from the center out.
- Do not use solvents such as benzene, thinner, commercially available cleaners or anti-static spray intended for vinyl LPs.
- Do not expose the disc to direct sunlight or heat sources such as hot air ducts nor leave it in a car parked in direct sunlight.
- Do not use discs encircled with a protection ring. This may cause a malfunction to the system.

- When using discs that have glue or similar tacky substance on the label side of the disc or that used a special ink when the label was printed, there is a chance that the disc or label may become attached to parts inside this unit. When this occurs, it may not be possible to remove the disc, and may also cause this system to malfunction. Be sure to check that the label side of the disc is not sticky before using.
The following types of disc should not be used:
 - rental or used discs with attached seals where the glue extends beyond the seal. The perimeter of the seal on the disc is tacky.
 - discs that have labels printed using a special ink that feels tacky when touched.
- Discs with non-standard shapes (e.g., heart, square, star) cannot be played back on this system.
Attempting to do so may damage the system. Do not use such discs.

Cleaning the cabinet

Clean the cabinet, panel and controls with a soft cloth slightly moistened with mild detergent solution. Do not use any type of abrasive pad, scouring powder or solvent such as thinner, benzene or alcohol.

To save a tape permanently

To prevent a tape from being accidentally recorded over, break off the tape tab from side A or B as illustrated.

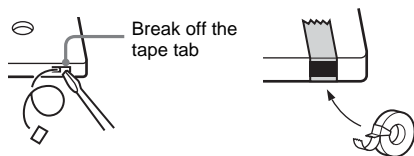

If you later want to reuse the tape for recording, cover the broken tab with adhesive tape.

Before placing a tape into the tape deck

Take up any slack in the tape deck. Otherwise, the tape may get entangled in the parts of the tape deck and become damaged.

When using a tape longer than 90 minutes

The tape is very elastic. Do not change the tape operations such as playback, stop and fast-winding etc. frequently. The tape may get entangled in the tape deck.

Cleaning the tape heads

Clean the tape heads after every 10 hours of use. Be sure to clean the tape heads before you start an important recording or after playing an old tape. Use a separately sold dry-type or wet-type cleaning tape. For details, refer to the instructions of the cleaning tape.

Demagnetizing the tape heads

Demagnetize the tape heads and the metal parts that have contact with the tape after every 20 to 30 hours of use with a separately sold demagnetizing tape. For details, refer to the instructions of the demagnetizing tape.

Specifications

AUDIO POWER SPECIFICATION (LBT-ZX80D USA model only)

POWER OUTPUT AND TOTAL HARMONIC DISTORTION:

With 6-ohm loads, both channels driven, from 120 Hz – 10 kHz; rates 160 watts per channel minimum RMS power, with no more than 10% total harmonic distortion from 250 milliwatts to rated output.

Continuous RMS power output (reference)

Front speaker: 200 W + 200 W
(6 ohms at 1 kHz, 10% THD)

Center speaker: 80 W
(16 ohms at 1 kHz, 10% THD)

Surround speaker: 200 W + 200 W
(6 ohms at 1 kHz, 10% THD)

Amplifier section

FST-ZX80D/LBT-ZX80D

The following are measured at AC 120 V, 60 Hz DIN power output (rated):

155 W + 155 W
(6 ohms at 1 kHz, DIN)

Continuous RMS power output (reference)

Front speaker: 200 W + 200 W
(6 ohms at 1 kHz, 10% THD)

Center speaker: 80 W
(16 ohms at 1 kHz, 10% THD)

Surround speaker: 200 W + 200 W
(6 ohms at 1 kHz, 10% THD)

FST-ZX100D/LBT-ZX100D

The following are measured at AC 120 V, 60 Hz
DIN power output (rated): 130 W + 130 W
(6 ohms at 1 kHz, DIN)
Continuous RMS power output (reference)
Front speaker: 170 W + 170 W
(6 ohms at 1 kHz, 10% THD)
Center speaker: 80 W
(16 ohms at 1 kHz, 10% THD)
Surround speaker: 170 W + 170 W
(6 ohms at 1 kHz, 10% THD)
Subwoofer: 180 W (8 ohms at 100 Hz, 10% THD)

MHC-GN1000D

The following are measured at AC 120 V, 60 Hz
DIN power output (rated): 125 W + 125 W
(6 ohms at 1 kHz, DIN)
Continuous RMS power output (reference)
Front speaker: 170 W + 170 W
(6 ohms at 1 kHz, 10% THD)
Center speaker: 70 W
(6 ohms at 1 kHz, 10% THD)
Surround speaker: 70 W + 70 W
(6 ohms at 1 kHz, 10% THD)
Subwoofer: 210 W (8 ohms at 100 Hz, 10% THD)

Inputs

VIDEO INPUT (phono jacks):
VIDEO: 1 Vp-p, 75 ohms
AUDIO L/R: Voltage
250 mV, impedance 47
kilohms

TV/SAT AUDIO IN L/R (phono jacks):
Voltage 250 mV/450 mV,
impedance 47 kilohms

MIC 1 or 2 (phone jack): Sensitivity 1 mV,
impedance 10 kilohms

Outputs

AUDIO OUT (phono jacks):
Voltage 250 mV,
impedance 1 kilohm

VIDEO OUT (phono jack):
Max. output level 1 Vp-p,
unbalanced, Sync.
negative load impedance
75 ohms

COMPONENT VIDEO OUT:

Y: 1 Vp-p, 75 ohms
PB/CB: 0.7 Vp-p, 75 ohms
Pr/Cr: 0.7 Vp-p, 75 ohms

S VIDEO OUT (4-pin/mini-DIN jack):

Y: 1 Vp-p, unbalanced,
Sync. negative
C: 0.286 Vp-p, load
impedance 75 ohms

PHONES (stereo mini jack):

accepts headphones of
8 ohms or more

FRONT SPEAKER: Use only the supplied
speakers

SURR SPEAKER: Use only the supplied
speakers

CENTER SPEAKER: Use only the supplied
speaker

SUBWOOFER OUT:

FST-ZX100D/LBT-ZX100D/MHC-GN1000D:
Use only the supplied
subwoofer

FST-ZX80D/LBT-ZX80D (phono jacks):
Voltage 250 mV,
impedance 1 kilohm

Disc player section

System Compact disc and digital
audio and video system
Laser Semiconductor laser
(DVD: $\lambda = 650$ nm,
CD: $\lambda = 790$ nm)
Emission duration:
continuous

Frequency response DVD (PCM 48 kHz):
2 Hz – 22 kHz (± 1 dB)
CD: 2 Hz – 20 kHz
(± 0.5 dB)

Video color system format
NTSC

Tape deck section

Recording system 4-track 2-channel stereo
Frequency response 50 – 13,000 Hz (± 3 dB),
using Sony TYPE I tape
Wow and flutter $\pm 0.15\%$ W.Peak (IEC)
0.1% W.RMS (NAB)
 $\pm 0.2\%$ W.Peak (DIN)

Tuner section

FM stereo, FM/AM superheterodyne tuner

FM tuner section

Tuning range	87.5 – 108.0 MHz (100 kHz step)
Antenna	FM lead antenna
Antenna terminals	75 ohms unbalanced
Intermediate frequency	10.7 MHz

AM tuner section

Tuning range	530 – 1,710 kHz (with the interval set at 10 kHz) 531 – 1,710 kHz (with the interval set at 9 kHz)
Antenna	AM loop antenna
Antenna terminals	External antenna terminal
Intermediate frequency	450 kHz

Speaker

Front/Surround speaker SS-ZX100D (FST-ZX100D/LBT-ZX100D/FST-ZX80D/ LBT-ZX80D)

Speaker system	2-way, bass-reflex type, magnetically shielded
Speaker units	
Woofer	22 cm (8 5/8 in.), cone type
Tweeter	5 cm (2 in.), cone type × 2
Nominal impedance	6 ohms
Dimensions (w/h/d)	Approx. 308 × 365 × 480 mm (12 1/8 × 14 3/8 × 18 7/8 in.)
Mass	Approx. 9.3 kg (20 lb 9 oz) net per speaker

Front speaker SS-GN1000D (MHC-GN1000D)

Speaker system	2-way, 2-unit, bass-reflex type, magnetically shielded
Speaker units	
Subwoofer	20 cm (7 7/8 in.), cone type
Tweeter	2.5 cm (1 in.), horn type
Nominal impedance	6 ohms
Dimensions (w/h/d)	Approx. 281 × 417 × 310.5 mm (11 × 16 3/8 × 12 1/4 in.)
Mass	Approx. 7.1 kg (15 lb 11 oz) net per speaker

Surround speaker SS-RSX1000D (MHC-GN1000D)

Speaker system	2-way, 2-units, bass-reflex type
Speaker units	
Woofer	10 cm (4 in.), cone type
Tweeter	5 cm (2 in.), horn type
Nominal impedance	6 ohms
Dimensions (w/h/d)	Approx. 176 × 362 × 215 mm (7 × 14 1/4 × 8 1/2 in.)
Mass	Approx. 2.9 kg (6 lb 7 oz) net per speaker

Center Speaker SS-CT100D (FST-ZX100D/ LBT-ZX100D/FST-ZX80D/LBT-ZX80D)

Speaker system	Full range, 2-unit, bass-reflex type, magnetically shielded
Speaker units	
Full range	8 cm (3 1/8 in.), cone type × 2
Nominal Impedance	16 ohms
Dimensions (w/h/d)	Approx. 268 × 107 × 117 mm (10 1/2 × 4 1/4 × 4 5/8 in.)
Mass	Approx. 1.6 kg (3 lb 9 oz)

Center Speaker SS-CT1000D (MHC-GN1000D)

Speaker system	Full range, 2-unit, bass-reflex type, magnetically shielded
Speaker units	
Full range	8 cm (3 1/8 in.), cone type × 2
Nominal Impedance	6 ohms
Dimensions (w/h/d)	Approx. 268 × 107 × 117 mm (10 1/2 × 4 1/4 × 4 5/8 in.)
Mass	Approx. 1.6 kg (3 lb 9 oz)

Subwoofer

SS-WGV100D (FST-ZX100D/LBT-ZX100D)/ SS-WGV1000D (MHC-GN1000D)

Subwoofer system	1-way, 1-unit, bass-reflex type, magnetically shielded
Speaker units	
Subwoofer:	20 cm (7 7/8 in.), cone type
Nominal impedance	8 ohms
Dimensions (w/h/d) (Approx.)	281 × 362 × 338.5 mm (11 × 14 1/4 × 13 3/8 in.)
Mass (Approx.)	6.8 kg (14 lb 16 oz)

General

Power requirements	120 V AC, 60 Hz
Power consumption	
FST-ZX100D/LBT-ZX100D	430 W
FST-ZX80D/LBT-ZX80D	390 W
MHC-GN1000D	345 W

Dimensions (w/h/d) (Approx.)	
HCD-ZX100D/HCD-ZX80D	281 × 379 × 404.5 mm (11 1/8 × 15 × 16 in.)
HCD-GN1000D	281 × 362 × 404.5 mm (11 1/8 × 14 1/4 × 16 in.)

Mass (Approx.)	
HCD-ZX100D/HCD-ZX80D	16.3 kg (35 lb 15 oz)
HCD-GN1000D	16.0 kg (35 lb 5 oz)

Supplied accessories:	Remote Commander (1)
	Batteries (2)
	AM loop antenna (1)
	FM lead antenna (1)
	Video cord (1)
	Front speaker pads (8)
	Surround speaker pads (8)
	Center speaker pads (4)
	Subwoofer pads (4)
	(FST-ZX100D/ LBT-ZX100D/ MHC-GN1000D only)
	Speaker cords (4):
	(FST-ZX100D/ LBT-ZX100D/ FST-ZX80D/ LBT-ZX80D only)
	– White for front speaker (left)
	– Red for front speaker (right)
	– Blue for surround speaker (left)
	– Grey for surround speaker (right)

Design and specifications are subject to change without notice.

Guide to the Control Menu display

Use the Control Menu to select a function and to view related information. Press  DISPLAY repeatedly to turn on, turn off or change the Control Menu display as follows:

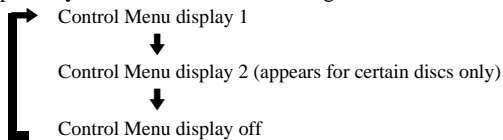







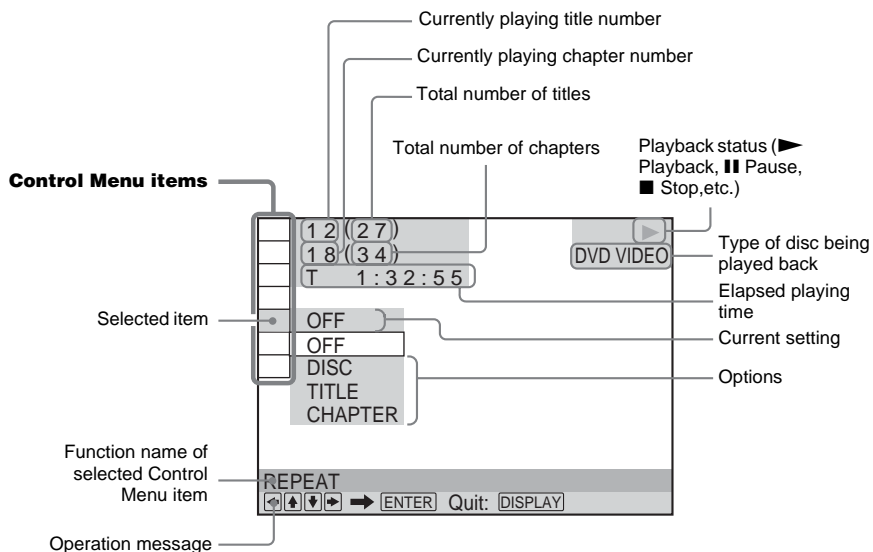



Control Menu display

The Control Menu display 1 and 2 will show different items depending on the disc type.

Example: Control Menu display 1 when playing a DVD VIDEO



List of Control Menu items

Item	Item Name, Function, Relevant Disc Type
	TITLE/SCENE/TRACK Selects the title, scene, or track to be played back. DVD-V DVD-VR VIDEO CD
	CHAPTER/INDEX Selects the chapter or index to be played back. DVD-V DVD-VR VIDEO CD
	TRACK Selects the track to be played back. C D DATA CD DATA DVD
	ORIGINAL/PLAY LIST Selects the playback sequence either to the originally recorded sequence or to the playlist created on the disc. DVD-VR
	TIME/TEXT Checks the elapsed playing time and the remaining time. Input the time code for picture and music searching. Displays the text information on the CD-TEXT discs, DVD TEXT discs and MP3 audio tracks. DVD-V DVD-VR VIDEO CD C D DATA CD DATA DVD
	PROGRAM Play back the track in the order you want. VIDEO CD C D
	SHUFFLE Play back the track in random order. VIDEO CD C D DATA CD DATA DVD
	REPEAT Play back all discs repeatedly, the entire disc (all titles/all tracks/all albums) repeatedly or one title/chapter/track/album/file repeatedly. DVD-V DVD-VR VIDEO CD C D DATA CD DATA DVD
	A/V SYNC Sets the delay time between the sound and display. DVD-V DVD-VR VIDEO CD
	PARENTAL CONTROL Set to prohibit playback on this system. DVD-V VIDEO CD C D
	SETUP QUICK Setup Use QUICK SETUP to choose the language of the on-screen display, the aspect ratio of the TV and the distance of the speakers you are using. CUSTOM Setup In addition to the Quick Setup setting, you can adjust other settings. RESET Returns the settings in "SETUP" to the default setting. DVD-V DVD-VR VIDEO CD C D DATA CD DATA DVD

Item	Item Name, Function, Relevant Disc Type
	ALBUM Selects the album to be played back. DATA CD DATA DVD
	FILE Selects the JPEG image file to be played back. DATA CD DATA DVD
	DATE Displays the date when the picture was taken by a digital camera. DATA CD DATA DVD
	INTERVAL Specifies the duration for which the slides are displayed on the TV screen. DATA CD DATA DVD
	EFFECT Selects the transition effects to be used for changing slides during a slide show. DATA CD DATA DVD
	MODE (MP3, JPEG) Selects the data type: MP3 audio track (AUDIO), JPEG image file (IMAGE) or both (AUTO) to be played back when playing a DATA CD or DATA DVD. DATA CD DATA DVD
	KEY CONTROL* Changes the key to suit your vocal range. DVD-V DVD-VR VIDEO CD C D DATA CD DATA DVD
	SCORE MODE* Selects the level for scoring mode. DVD-V DVD-VR VIDEO CD C D DATA CD DATA DVD
	KARAOKE PON* Enjoys karaoke with a stereo-recorded disc by reducing the sound of the vocals. DVD-V DVD-VR VIDEO CD C D DATA CD DATA DVD
	VOCAL* Turns on or off the guide vocal for Dolby Digital Karaoke Format disc (DVD VIDEO only). Turns on or off the vocal (VIDEO CD, AUDIO CD only). DVD-V VIDEO CD C D
	VOCAL SELECT* Selects the guide vocal recorded on the Dolby Digital Karaoke Format disc (DVD VIDEO only). Selects the vocal type recorded on the disc (VIDEO CD, AUDIO CD only). DVD-V VIDEO CD C D
	GUIDE MELODY* Turns on or off the guide melody for Dolby Digital Karaoke Format disc. DVD-V

* This function is only available during karaoke mode.

DVD setup menu item list

You can set the following items with the DVD setup menu.

The default settings are underlined.

LANGUAGE SETUP (page 41)

OSD	Select the language you want to use from the displayed language list.
MENU	Select the language you want to use from the displayed language list.
AUDIO	Select the language you want to use from the displayed language list.
SUBTITLE	Select the language you want to use from the displayed language list.

SCREEN SETUP (page 41)

TV TYPE	<u>4:3 LETTER BOX</u> 4:3 PAN SCAN 16:9
SCREEN SAVER	<u>ON</u> OFF
BACKGROUND	<u>JACKET PICTURE</u> GRAPHICS BLUE BLACK
BLACK LEVEL	<u>ON</u> OFF
BLACK LEVEL (COMPONENT OUT)	<u>OFF</u> ON
4:3 OUTPUT	<u>FULL</u> NORMAL

CUSTOM SETUP (page 43)

PAUSE MODE	<u>AUTO</u> FRAME
TRACK SELECTION	<u>OFF</u> AUTO
MULTI-DISC RESUME	<u>ON</u> OFF
AUDIO DRC	<u>OFF</u> STANDARD MAX

SPEAKER SETUP (page 44)

SIZE	FRONT	<u>YES</u>
	CENTER	<u>YES</u> NONE
	SURROUND	<u>BEHIND</u> SIDE NONE
	SUBWOOFER	<u>YES</u> NONE
DISTANCE	FRONT	<u>10ft 3.0m</u> (3 ft – 23 ft (0.9 m – 6.9 m))
	CENTER	<u>10ft 3.0m</u> (0 ft – 23 ft (0.0 m – 6.9 m))
	SURROUND	<u>10ft 3.0m</u> (0 ft – 23 ft (0.0 m – 6.9 m))
LEVEL (FRONT)	L	<u>0.0 dB</u> (–6.0 dB – 0.0 dB)
	R	<u>0.0 dB</u> (–6.0 dB – 0.0 dB)
	CENTER	<u>0.0 dB</u> (–6.0 dB – +6.0 dB)
	SUBWOOFER	<u>0.0 dB</u> (–6.0 dB – +6.0 dB for FST-ZX100D/ LBT-ZX100D/ MHC-GN1000D) (–10.0 dB – +10.0 dB for FST-ZX80D/ LBT-ZX80D)
LEVEL (SURROUND)	L	<u>0.0 dB</u> (–6.0 dB – +6.0 dB)
	R	<u>0.0 dB</u> (–6.0 dB – +6.0 dB)
TEST TONE	<u>OFF</u> ON	

SETUP (page 14, 40, 79)

QUICK	
CUSTOM	
RESET	YES NO

Language code list

For details, see page 41.

The language spellings conform to the ISO 639:1988 (E/F) standard.

Code	Language	Code	Language	Code	Language	Code	Language
1027	Afar	1186	Scots Gaelic	1350	Malayalam	1513	Siswati
1028	Abkhazian	1194	Galician	1352	Mongolian	1514	Sesotho
1032	Afrikaans	1196	Guarani	1353	Moldavian	1515	Sundanese
1039	Amharic	1203	Gujarati	1356	Marathi	1516	Swedish
1044	Arabic	1209	Hausa	1357	Malay	1517	Swahili
1045	Assamese	1217	Hindi	1358	Maltese	1521	Tamil
1051	Aymara	1226	Croatian	1363	Burmese	1525	Telugu
1052	Azerbaijani	1229	Hungarian	1365	Nauru	1527	Tajik
1053	Bashkir	1233	Armenian	1369	Nepali	1528	Thai
1057	Byelorussian	1235	Interlingua	1376	Dutch	1529	Tigrinya
1059	Bulgarian	1239	Interlingue	1379	Norwegian	1531	Turkmen
1060	Bihari	1245	Inupiak	1393	Occitan	1532	Tagalog
1061	Bislama	1248	Indonesian	1403	(Afan) Oromo	1534	Setswana
1066	Bengali; Bangla	1253	Icelandic	1408	Oriya	1535	Tonga
1067	Tibetan	1254	Italian	1417	Punjabi	1538	Turkish
1070	Breton	1257	Hebrew	1428	Polish	1539	Tsonga
1079	Catalan	1261	Japanese	1435	Pashto; Pushto	1540	Tatar
1093	Corsican	1269	Yiddish	1436	Portuguese	1543	Twi
1097	Czech	1283	Javanese	1463	Quechua	1557	Ukrainian
1103	Welsh	1287	Georgian	1481	Rhaeto-Romance	1564	Urdu
1105	Danish	1297	Kazakh	1482	Kirundi	1572	Uzbek
1109	German	1298	Greenlandic	1483	Romanian	1581	Vietnamese
1130	Bhutani	1299	Cambodian	1489	Russian	1587	Volapük
1142	Greek	1300	Kannada	1491	Kinyarwanda	1613	Wolof
1144	English	1301	Korean	1495	Sanskrit	1632	Xhosa
1145	Esperanto	1305	Kashmiri	1498	Sindhi	1665	Yoruba
1149	Spanish	1307	Kurdish	1501	Sangho	1684	Chinese
1150	Estonian	1311	Kirghiz	1502	Serbo-Croatian	1697	Zulu
1151	Basque	1313	Latin	1503	Singhalese	1703	Not specified
1157	Persian	1326	Lingala	1505	Slovak		
1165	Finnish	1327	Laothian	1506	Slovenian		
1166	Fiji	1332	Lithuanian	1507	Samoa		
1171	Faroese	1334	Latvian; Lettish	1508	Shona		
1174	French	1345	Malagasy	1509	Somali		
1181	Frisian	1347	Maori	1511	Albanian		
1183	Irish	1349	Macedonian	1512	Serbian		

Glossary

Album

Section of a music or picture piece on a DATA CD or DATA DVD containing MP3 audio tracks or JPEG image files.

Chapter

Subdivision of a title on a DVD VIDEO. A title is composed of several chapters.

Dolby Digital

This sound format for movie theaters is more advanced than Dolby Surround Pro Logic. In this format, the surround speakers output stereo sound with an expanded frequency range and a subwoofer channel for deep bass is independently provided. This format is also called "5.1" because the subwoofer channel is counted as 0.1 channel (since it functions only when a deep bass effect is needed). All six channels in this format are recorded separately to realize superior channel separation. Furthermore, since all the signals are processed digitally, less signal degradation occurs.

Dolby Pro Logic II

This technology converts 2 channel stereo recorded audio into 5.1 channels for playback. There is a MOVIE mode for movies and MUSIC mode for stereo sources such as music. Old movies encoded in traditional stereo format can be enhanced with 5.1 channel surround sound.

Movie mode

The Movie mode is for use with stereo television shows and all the programmes encoded in Dolby Surround. The result is enhanced sound field directionality that approaches the quality of discrete 5.1-channel sound.

Music mode

The Music mode is for use with any stereo music recordings, and provides a wide and deep sound space.

Dolby Surround Pro Logic

As one method of Dolby Surround decoding, Dolby Surround Pro Logic produces four channels from two-channel sound. Compared with the former Dolby Surround system, Dolby Surround Pro Logic reproduces left-to-right panning more naturally and localizes sounds more precisely. To take full advantages of Dolby Surround Pro Logic, you should have one pair of surround speakers and a center speaker. The surround speakers output monaural sound.

DTS

Digital audio compression technology that the Digital Theater Systems, Inc. developed. This technology conforms to 5.1-channel surround. The surround channel is stereo and there is discrete subwoofer channel in this format. DTS provides the same 5.1 discrete channels of high quality digital audio. The good channel separation is realized because the all channel data is recorded discrete and processed in digital.

DVD VIDEO

A disc that contains up to 8 hours of moving pictures even though its diameter is the same as a AUDIO CD.

The data capacity of a single-layer and single-sided DVD VIDEO, at 4.7 GB (Giga Byte), is 7 times that of a AUDIO CD. Furthermore, the data capacity of a dual-layer and single-sided DVD VIDEO is 8.5 GB, a single-layer and double-sided DVD VIDEO 9.4 GB, and a dual-layer and double-sided DVD VIDEO 17 GB. The picture data uses the MPEG 2 format, one of the worldwide standards for digital compression technology. The picture data is compressed to about 1/40 of its original size. The DVD VIDEO also uses variable rate coding technology that changes the data to be allocated according to the status of the picture.

The audio data is recorded in Dolby Digital as well as in PCM, allowing you to enjoy more realistic audio presence.

Furthermore, various advanced functions such as the multi-angle, multilingual, and Parental Control functions are provided with the DVD VIDEO.

DVD-RW

A DVD-RW is a recordable and rewritable disc that is the same size as a DVD VIDEO. The DVD-RW has two different modes: VR mode and Video mode. DVD-RWs created in Video mode have the same format as a DVD VIDEO, while discs created in VR (Video Recording) mode allow the contents to be programmed or edited.

DVD+RW

A DVD+RW (plus RW) is a recordable and rewritable disc. DVD+RWs use a recording format that is comparable to the DVD VIDEO format.

File

A JPEG image file recorded on a DATA CD or DATA DVD. ("File" is an exclusive definition for this system.) A single file consists of a single image or movie.

Film based software, Video based software

DVD VIDEOS can be classified as Film based or Video based software. Film based DVD VIDEOS contain the same images (24 frames per second) that are shown at movie theaters. Video based DVD VIDEOS, such as television dramas or sitcoms, displays images at 30 frames (or 60 fields) per second.

Index (AUDIO CD) / Video Index (VIDEO CD)

A number that divides a track into sections to easily locate the point you want on a VIDEO CD or an AUDIO CD. Depending on the disc, no indexes may be recorded.

Interlace format (Interlaced scanning)

The Interlace format is the NTSC standard method for displaying TV images at 30 frames per second. Each frame is scanned twice—alternately between the even numbered scanning lines and then odd numbered scanning lines, at 60 times per second.

Menu Playback

Playback using the menu screens recorded on VIDEO CDs with PBC functions. You can enjoy simple interactive software using the menu playback function.

Multi-angle function

Various angles, or viewpoints of the video camera, for a scene are recorded on some DVD VIDEOS.

Multilingual function

Several languages for the sound or subtitles in a picture are recorded on some DVD VIDEOS.

Multi Session

This is a recording method that enables adding of data using the Track-At-Once method. Conventional CDs begin at a CD control area called the Lead-in and end at an area called Lead-out. A Multi Session disc is a disc having multiple sessions, with each segment from Lead-in to Lead-out regarded as a single session.

Parental Control

A function of the DVD VIDEO to limit playback of the disc by the age of the users according to the limitation level in each country. The limitation varies from disc to disc; when it is activated, playback is completely prohibited, violent scenes are skipped or replaced with other scenes and so on.

Playback Control (PBC)

Signals encoded on VIDEO CDs (Version 2.0) to control playback. By using menu screens recorded on VIDEO CDs with PBC functions, you can enjoy playing simple interactive programs, programs with search functions, and so on.

This system conforms to Version 1.1 and Version 2.0 of VIDEO CD standards. You can enjoy two kinds of playback depending on the disc type.

VIDEO CDs without PBC functions (Version. 1.1 discs)

Enjoy video playback (moving pictures) as well as music.

VIDEO CDs with PBC functions (Version. 2.0 discs)

Play back interactive software using menu screens displayed on the TV screen (PBC Playback), in addition to the video playback function of Version 1.1 discs. Moreover, you can play high-resolution still pictures, if they are included on the disc.

Progressive format (sequential scanning)

Compared to the Interlace format that alternately shows every other line of an image (field) to create one frame, the Progressive format shows the entire image at once as a single frame. This means that while the Interface format can show 30 frames (60 fields) in one second, the Progressive format can show 60 frames in one second. The overall picture quality increases and still images, text, and horizontal lines appear sharper. This system is compatible with 525 progressive format.

Region Code

This system is used to protect copyrights. A region code is allocated on each DVD system or DVD VIDEO according to the sales region. Each region code is shown on the unit as well as on the disc packaging. The system can play back the discs that match its region code. The system can also play back discs with the “” mark. Even when the region code is not shown on the DVD VIDEO, the region limit may still be activated.

Scene

On a VIDEO CD with PBC functions, the menu screens, moving pictures and still pictures are divided into sections called “scenes”. Each scene is assigned a scene number enabling you to locate the scene you want.

Title

The longest section of a picture or a music piece on a DVD VIDEO; a movie, etc., for a picture piece on video software; or an album, etc., for a music piece on audio software. Each title is assigned a title number enabling you to locate the title you want.

Track

Sections of a picture or a music piece on an AUDIO CD, VIDEO CD, DATA CD or DATA DVD. Each track is assigned a track number enabling you to locate the track you want.

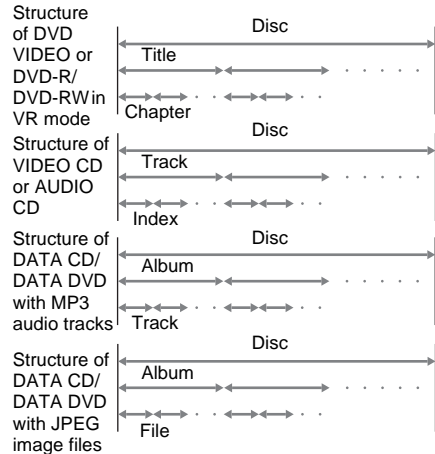

VIDEO CD

A compact disc that contains moving pictures. The picture data uses the MPEG 1 format, one of the worldwide standards for digital compression technology. The picture data is compressed to about 1/140 of its original size. Consequently, a 12 cm VIDEO CD can contain up to 74 minutes of moving pictures.

VIDEO CDs also contain compact audio data. Sound outside the range of human hearing are compressed while the sounds we can hear are not compressed. VIDEO CDs can hold 6 times the audio information of conventional AUDIO CDs.

There are 2 versions of VIDEO CDs.

- Version 1.1: You can play back only moving pictures and sounds.
- Version 2.0: You can play back high-resolution still pictures and enjoy PBC functions.

This system conforms to both versions.

Front Panel

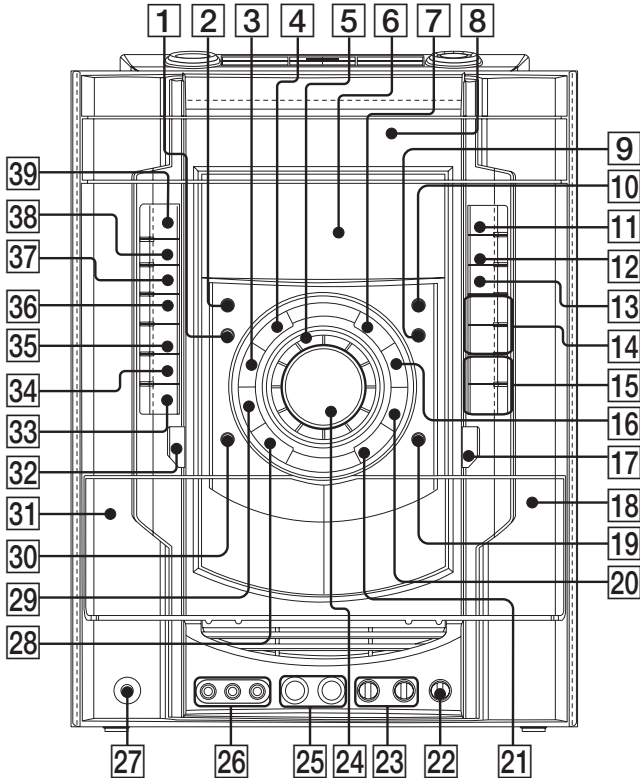

Top Panel

Buttons numbered 40 to 48 are for models FST-ZX100D, LBT-ZX100D, FST-ZX80D and LBT-ZX80D only.

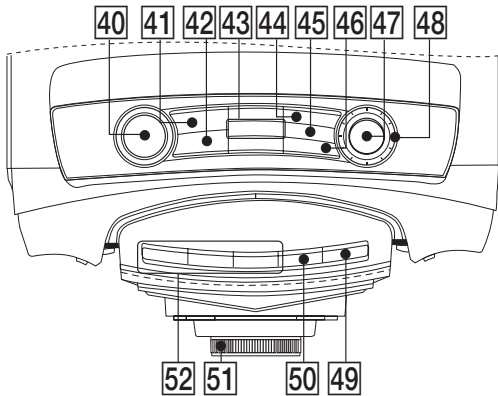

Subwoofer

(FST-ZX100D/LBT-ZX100D/MHC-GN1000D only)

ALPHABETICAL ORDER

A - Z

- SUBWOOFER ON/OFF **1** (54)
- SUBWOOFER LEVEL **2** (54)

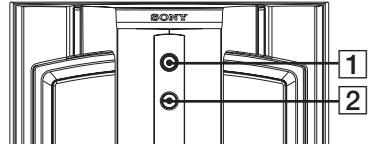

Remote control

ALPHABETICAL ORDER

A - L

- ADVANCE **•→** **24** (18)
- ALBUM +/- **11** (15, 18)
- ANGLE **10** (35)
- AUDIO **8** (27, 34, 58, 61, 73)
- CLEAR **28** (15, 21–23, 28, 32, 44)
- DISC SKIP **3** (18, 21, 22)
- DISPLAY **33** (66, 68)
- ENTER **26** (14, 18, 20–24, 27, 29, 32, 33, 36–40, 44, 46–49, 59–62, 64–66, 79)
- FM MODE **7** (49, 78)
- FUNCTION +/- **4** (14, 16, 18, 47–50, 58, 65, 73, 77)
- KARAOKE MODE **31** (59, 73, 77)
- KARAOKE PON **30** (59)
- KEY CONTROL #/b **32** (60)

M - S

- MENU **12** (24, 25, 27–29, 47, 48)
- Numeric Buttons¹⁾ **29** (11, 15, 18, 24, 25, 32, 37–40, 41, 49)
- PICTURE NAVI **6** (28, 29, 33)
- PRESET + **16** (48, 49)
- PRESET - **23** (48, 49)
- REPEAT **7** (23)
- REPLAY **←•** **24** (18)
- SCORE **5** (63)
- SLEEP **35** (15, 64)
- SLOW **▶▶** **17** (18)
- SLOW **◀◀** **22** (18)

- SOUND FIELD **13** (53, 54, 57, 58, 73)
- STEP **▶▶** **24** (18)
- SUBTITLE **9** (35)

T - Z

- THEATRE SYNC **1** (15)
- TIMER MENU **36** (13, 64–66)
- TIME/TEXT **34** (68, 69)
- TOP MENU **27** (24)
- TUNING + **17** (47–49)
- TUNING - **22** (47–49)
- TV **20** (11)
- TV CH + **16** (11)
- TV CH - **23** (11)
- TV/VIDEO **35** (11)
- TV VOL +/-¹⁾ **14** (11)
- TV **I/⏻** (on/standby) **2** (11)
- VOLUME +/-¹⁾ **14** (18, 46, 47, 55, 64, 68, 74)

NUMBERS AND SYMBOLS

- I/⏻** (on/standby) **2** (11, 13, 64, 65, 74)
- (stop) **18** (18, 19, 25, 27, 28, 29, 36, 48, 50, 65, 76)
- ||** (pause) **19** (18, 50)
- ▶¹⁾** (play) **21** (18, 21, 25, 28, 29, 39, 42, 50–52, 63, 65, 74, 76)
- ▶▶** (go forward) **16** (15, 18, 25, 27, 52, 78)
- ◀◀** (go backward) **23** (18, 25, 27, 52, 78)
- ▶▶** (fast forward) **17** (18, 50)
- ◀◀** (rewind) **22** (18, 50)

- ▲/▼/◀/▶** **26** (13, 14, 20–24, 27–33, 36–40, 46, 47, 53, 59–62, 64–66, 79)
- 10/0 **29**
- /- **28** (11)
- ↶** RETURN **25** (24, 27, 33)
- ☰** DISPLAY **15** (14, 20, 21–24, 29, 30, 31–33, 36, 38, 40, 46, 59–62, 70, 79, 86)
- ◀▶** STEP **24** (18)

¹⁾ The numeric button 5, TV VOL +, VOLUME + and **▶** buttons have a tactile dot. Use the tactile dot as a reference when operating the system.

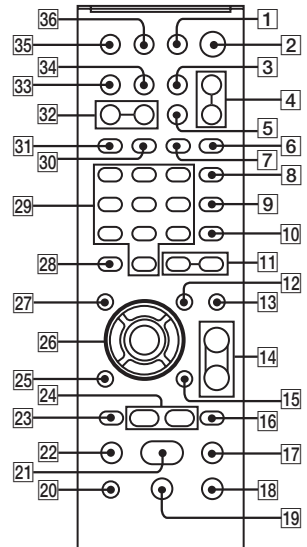

* 2 6 7 2 1 4 0 3 1 * (1)